



NexAIoT Co., Ltd.

**IoT Automation Solutions Business Group**

**Fan-less Computer**

**CPS 50-N01**

User Manual

# CONTENTS

## Preface

Copyright .....	iv
Disclaimer .....	iv
Acknowledgements .....	iv
Regulatory Compliance Statements .....	iv
Declaration of Conformity .....	iv
RoHS Compliance .....	v
Warranty and RMA .....	vi
Installation Recommendations .....	vii
Safety Information .....	viii
Safety Precautions .....	ix
Technical Support and Assistance .....	x
Conventions Used in this Manual .....	x
Global Service Contact Information .....	xi
Package Contents .....	xiii
Ordering Information .....	xiv

## Chapter 1: Product Introduction

CPS 50-N01 Overview .....	1
CPS 50-N01 Hardware Specifications .....	2
Knowing Your CPS 50-N01 .....	4
Front Panel .....	4
Rear Panel .....	4
CPS 50-N01 Mechanical Dimensions .....	5

## Chapter 2: Jumpers and Connectors

Before You Begin .....	6
Precautions .....	6
Jumper Settings .....	7
Locations of the Jumpers and Connectors for CPS 50-N01 .....	8
Jumps .....	9
Power Mode Select .....	9
Connector Pin Definitions .....	10
External I/O Interfaces .....	10
RS232/485/422 Connector .....	10
HDMI Connector .....	10
USB Ports .....	11
DC Power Input .....	12
Functional Ground Isolation .....	12
LAN Ports .....	13
Power Button .....	14
Internal Connectors .....	15
DSI Touch Connector .....	15
SIM Card Connector .....	15
Mini-PCIe Slot .....	16
Board to Board Connector .....	17
Board to Board Connector .....	17
LVDS Connector .....	18
Micro SD Card Slot .....	19
M.2 Connector (Key E 2330) .....	20

- Battery Connector ..... 21
- MIC Connector ..... 21
- MIPI-DSI Connector ..... 22
- UART2 Connector ..... 23
- MIPI-CSI Connector ..... 23
- LVDS Touch Connector ..... 24
- Block Diagram ..... 25

### Chapter 3: System Setup

- Removing the Chassis Cover ..... 25
- Installing a Micro SD Card ..... 26
- Installing a WLAN/5G/4G LTE Module (Full-size mini-PCIe) ..... 28
- Installing a WLAN/ Bluetooth Mini-PCIe Module (Half-size mini-PCIe) ... 30
- Installing a M.2 Key E Module (2230) ..... 31
- Installing a Nano SIM Card ..... 33
- Installing an Antenna ..... 35

### Chapter 4: Software Functionality

- Build Yocto Linux, Ubuntu, or Android image for CPS50 ..... 38
  - Yocto Linux ..... 38
  - Ubuntu ..... 38
  - Android ..... 42
- Install Yocto Linux, Ubuntu, or Android on CPS50 ..... 43
  - Yocto Linux ..... 43
  - Ubuntu ..... 45
  - Android ..... 47
- Yocto Linux Test Command on CPS50 ..... 48
  - HDMI ..... 48
  - LVDS panel backlight ..... 49
  - MIPI-DSI panel backlight ..... 50
  - Camera ..... 50

- Audio ..... 51
- Wi-Fi ..... 53
- Bluetooth ..... 53
- Ethernet ..... 54
- 4G LTE ..... 55
- CAN bus ..... 55
- LED ..... 56
- Serial Port RS-232/RS-422/RS-485 ..... 56
- UIO-4030: 4 DI & 4 DO ..... 61
- UIO-4030: 4 DI & 4 DO ..... 62
- NEXCOM IO board (CPSK-501) UIO\_GPIO ..... 63
- RTC ..... 64
- Watchdog ..... 64
- USB storage copy file ..... 65
- MicroSD card copy file ..... 65
- i2c reset PMIC pca9450 ..... 66
- Thermal CPU & SoC temperature ..... 66
- Thermal CPU & SoC passive & critical temperature setting ..... 67
- CPU Frequency ..... 67
- CPU Frequency & CPU & SoC temperature ..... 68
- ATECC608A ..... 68

### Appendix A: System Recovery

- Before the System Restore ..... 69
- Restoring the Operating System ..... 69

# PREFACE

## Copyright

This publication, including all photographs, illustrations and software, is protected under international copyright laws, with all rights reserved. No part of this manual may be reproduced, copied, translated or transmitted in any form or by any means without the prior written consent from NexAloT Co., Ltd.

## Disclaimer

The information in this document is subject to change without prior notice and does not represent commitment from NexAloT Co., Ltd. However, users may update their knowledge of any product in use by constantly checking its manual posted on our website: <http://www.nexaiot.com>. NexAloT shall not be liable for direct, indirect, special, incidental, or consequential damages arising out of the use of any product, nor for any infringements upon the rights of third parties, which may result from such use. Any implied warranties of merchantability or fitness for any particular purpose is also disclaimed.

## Acknowledgements

CPS 50-N01 is the trademark of NexAloT Co., Ltd. All other product names mentioned herein are registered trademarks of their respective owners.

## Regulatory Compliance Statements

This section provides the FCC compliance statement for Class A devices and describes how to keep the system CE compliant.

## Declaration of Conformity

### FCC

This equipment has been tested and verified to comply with the limits for a Class A digital device, pursuant to Part 15 of FCC Rules. These limits are designed to provide reasonable protection against harmful interference when the equipment is operated in a commercial environment. This equipment generates, uses, and can radiate radio frequency energy and, if not installed and used in accordance with the instructions, may cause harmful interference to radio communications. Operation of this equipment in a residential area (domestic environment) is likely to cause harmful interference, in which case the user will be required to correct the interference (take adequate measures) at their own expense.

### CE

The product(s) described in this manual complies with all applicable European Union (CE) directives if it has a CE marking. For computer systems to remain CE compliant, only CE-compliant parts may be used. Maintaining CE compliance also requires proper cable and cabling techniques.

## RoHS Compliance



### NexAloT RoHS Environmental Policy and Status Update

NexAloT is a global citizen for building the digital infrastructure. We are committed to providing green products and services, which are compliant with European Union RoHS (Restriction on Use of Hazardous Substance in Electronic Equipment) directive 2011/65/EU, to be your trusted green partner and to protect our environment.

RoHS restricts the use of Lead (Pb) < 0.1% or 1,000ppm, Mercury (Hg) < 0.1% or 1,000ppm, Cadmium (Cd) < 0.01% or 100ppm, Hexavalent Chromium (Cr6+) < 0.1% or 1,000ppm, Polybrominated biphenyls (PBB) < 0.1% or 1,000ppm, and Polybrominated diphenyl Ethers (PBDE) < 0.1% or 1,000ppm.

In order to meet the RoHS compliant directives, NexAloT has established an engineering and manufacturing task force to implement the introduction of green products. The task force will ensure that we follow the standard NexAloT development procedure and that all the new RoHS components and new manufacturing processes maintain the highest industry quality levels for which NexAloT are renowned.

The model selection criteria will be based on market demand. Vendors and suppliers will ensure that all designed components will be RoHS compliant.

### How to recognize NexAloT RoHS Products?

For existing products where there are non-RoHS and RoHS versions, the suffix "(LF)" will be added to the compliant product name.

All new product models launched after January 2013 will be RoHS compliant. They will use the usual NexAloT naming convention.

## Warranty and RMA

### NexAloT Warranty Period

NexAloT manufactures products that are new or equivalent to new in accordance with industry standard. NexAloT warrants that products will be free from defect in material and workmanship for 2 years, beginning on the date of invoice by NexAloT.

### NexAloT Return Merchandise Authorization (RMA)

- Customers shall enclose the “NexAloT RMA Service Form” with the returned packages.
- Customers must collect all the information about the problems encountered and note anything abnormal or, print out any on-screen messages, and describe the problems on the “NexAloT RMA Service Form” for the RMA number apply process.
- Customers can send back the faulty products with or without accessories (manuals, cable, etc.) and any components from the card, such as CPU and RAM. If the components were suspected as part of the problems, please note clearly which components are included. Otherwise, NexAloT is not responsible for the devices/parts.
- Customers are responsible for the safe packaging of defective products, making sure it is durable enough to be resistant against further damage and deterioration during transportation. In case of damages occurred during transportation, the repair is treated as “Out of Warranty.”
- Any products returned by NexAloT to other locations besides the customers’ site will bear an extra charge and will be billed to the customer.

### Repair Service Charges for Out-of-Warranty Products

NexAloT will charge for out-of-warranty products in two categories, one is basic diagnostic fee and another is component (product) fee.

#### System Level

- Component fee: NexAloT will only charge for main components such as SMD chip, BGA chip, etc. Passive components will be repaired for free, ex: resistor, capacitor.
- Items will be replaced with NexAloT products if the original one cannot be repaired. Ex: motherboard, power supply, etc.
- Replace with 3rd party products if needed.
- If RMA goods can not be repaired, NexAloT will return it to the customer without any charge.

#### Board Level

- Component fee: NexAloT will only charge for main components, such as SMD chip, BGA chip, etc. Passive components will be repaired for free, ex: resistors, capacitors.
- If RMA goods can not be repaired, NexAloT will return it to the customer without any charge.

## Warnings

Read and adhere to all warnings, cautions, and notices in this guide and the documentation supplied with the chassis, power supply, and accessory modules. If the instructions for the chassis and power supply are inconsistent with these instructions or the instructions for accessory modules, contact the supplier to find out how you can ensure that your computer meets safety and regulatory requirements.

## Cautions

Electrostatic discharge (ESD) can damage system components. Do the described procedures only at an ESD workstation. If no such station is available, you can provide some ESD protection by wearing an antistatic wrist strap and attaching it to a metal part of the computer chassis.

## Installation Recommendations

Ensure you have a stable, clean working environment. Dust and dirt can get into components and cause a malfunction. Use containers to keep small components separated.

Adequate lighting and proper tools can prevent you from accidentally damaging the internal components. Most of the procedures that follow require only a few simple tools, including the following:

- A Philips screwdriver
- A flat-tipped screwdriver
- A grounding strap
- An anti-static pad

Using your fingers can disconnect most of the connections. It is recommended that you do not use needle-nose pliers to disconnect connections as these can damage the soft metal or plastic parts of the connectors.

## Safety Information

Before installing and using the device, note the following precautions:

- Read all instructions carefully.
- Do not place the unit on an unstable surface, cart, or stand.
- Follow all warnings and cautions in this manual.
- When replacing parts, ensure that your service technician uses parts specified by the manufacturer.
- Avoid using the system near water, in direct sunlight, or near a heating device.
- The load of the system unit does not solely rely for support from the rackmounts located on the sides. Firm support from the bottom is highly necessary in order to provide balance stability.
- The computer is provided with a battery-powered real-time clock circuit. There is a danger of explosion if battery is incorrectly replaced. Replace only with the same or equivalent type recommended by the manufacturer. Discard used batteries according to the manufacturer's instructions.



Danger of explosion if battery is incorrectly replaced. Replace with the same or equivalent type recommended by the manufacturer. Discard used batteries according to the manufacturer's instructions.



ATTENTION  
IL Y A RISQUE D'EXPLOSION SI LA BATTERIE EST REMPLACÉE  
PAR UNE BATTERIE DE TYPE INCORRECT.  
METTRE AU REBUT LES BATTERIES USAGÉES  
CONFORMÉMENT AUX INSTRUCTIONS.



## Safety Precautions

1. Read these safety instructions carefully.
2. Keep this User Manual for later reference.
3. Disconnect this equipment from any AC outlet before cleaning. Use a damp cloth. Do not use liquid or spray detergents for cleaning.
4. For plug-in equipment, the power outlet socket must be located near the equipment and must be easily accessible.
5. Keep this equipment away from humidity.
6. Put this equipment on a stable surface during installation. Dropping it or letting it fall may cause damage.
7. The openings on the enclosure are for air convection to protect the equipment from overheating. **DO NOT COVER THE OPENINGS.**
8. Make sure the voltage of the power source is correct before connecting the equipment to the power outlet.
9. Place the power cord in a way so that people will not step on it. Do not place anything on top of the power cord. Use a power cord that has been approved for use with the product and that it matches the voltage and current marked on the product's electrical range label. The voltage and current rating of the cord must be greater than the voltage and current rating marked on the product.
10. All cautions and warnings on the equipment should be noted.
11. If the equipment is not used for a long time, disconnect it from the power source to avoid damage by transient overvoltage.
12. Never pour any liquid into an opening. This may cause fire or electrical shock.
13. This equipment is not suitable for use in locations where children are likely to be present.
14. Ensure to connect the power cord to a socket-outlet with earthing connection.
15. Never open the equipment. For safety reasons, the equipment should be opened only by qualified service personnel.
16. If one of the following situations arises, get the equipment checked by service personnel:
  - a. The power cord or plug is damaged.
  - b. Liquid has penetrated into the equipment.
  - c. The equipment has been exposed to moisture.
  - d. The equipment does not work well, or you cannot get it to work according to the user's manual.
  - e. The equipment has been dropped and damaged.
  - f. The equipment has obvious signs of breakage.
17. Do not place heavy objects on the equipment.
18. The unit uses a three-wire ground cable which is equipped with a third pin to ground the unit and prevent electric shock. Do not defeat the purpose of this pin. If your outlet does not support this kind of plug, contact your electrician to replace your obsolete outlet.
19. **CAUTION: DANGER OF EXPLOSION IF BATTERY IS INCORRECTLY REPLACED. REPLACE ONLY WITH THE SAME OR EQUIVALENT TYPE RECOMMENDED BY THE MANUFACTURER. DISCARD USED BATTERIES ACCORDING TO THE MANUFACTURER'S INSTRUCTIONS.**

## Technical Support and Assistance

1. For the most updated information of NexAloT products, visit NexAloT's website at [www.nexaiot.com](http://www.nexaiot.com).
2. For technical issues that require contacting our technical support team or sales representative, please have the following information ready before calling:
  - Product name and serial number
  - Detailed information of the peripheral devices
  - Detailed information of the installed software (operating system, version, application software, etc.)
  - A complete description of the problem
  - The exact wordings of the error messages

### Warning!

1. Handling the unit: carry the unit with both hands and handle it with care.
2. Maintenance: to keep the unit clean, use only approved cleaning products or clean with a dry cloth.

## Conventions Used in this Manual



### Warning:

Information about certain situations, which if not observed, can cause personal injury. This will prevent injury to yourself when performing a task.



### Caution:

Information to avoid damaging components or losing data.



### Note:

Provides additional information to complete a task easily.

## Global Service Contact Information

### Headquarters

#### **NEXCOM International Co., Ltd.**

9F, No. 920, Zhongzheng Rd.,  
Zhonghe District, New Taipei City, 23586,  
Taiwan, R.O.C.  
Tel: +886-2-8226-7786  
Fax: +886-2-8226-7782  
www.nexcom.com

### Asia

#### **Taiwan**

#### **NexAIoT Headquarters**

#### **Industry 4.0 and Cloud Services**

13F, No.922, Zhongzheng Rd.,  
Zhonghe District, New Taipei City,  
23586, Taiwan, R.O.C.  
Tel: +886-2-8226-7796  
Fax: +886-2-8226-7926  
Email: jacobhuang@nexaiot.com  
www.nexaiot.com

#### **NexAIoT Co., Ltd.**

#### **Taichung Office**

16F, No.250, Sec. 2, Chongde Rd.,  
Beitun District,  
Taichung City, 406, Taiwan, R.O.C.  
Tel: +886-4-2249-1179  
Fax: +886-4-2249-1172  
Email: jacobhuang@nexaiot.com  
www.nexaiot.com

#### **NexCOBOT Taiwan Co., Ltd.**

13F, No.916, Zhongzheng Rd.,  
Zhonghe District,  
New Taipei City, 23586, Taiwan, R.O.C.  
Tel: +886-2-8226-7786  
Fax: +886-2-8226-7926  
Email: jennyshern@nexcobot.com  
www.nexcobot.com

#### **GreenBase Technology Corp.**

13F, No.922, Zhongzheng Rd.,  
Zhonghe District,  
New Taipei City, 23586, Taiwan, R.O.C.  
Tel: +886-2-8226-7786  
Fax: +886-2-8226-7900  
Email: vivianlin@nexcom.com.tw  
www.nexcom.com.tw

#### **DivioTec Inc.**

19F-1A, No.97, Sec.4, ChongXin Rd.,  
Sanhong District,  
New Taipei City, 24161, Taiwan, R.O.C.  
Tel: +886-2-8976-3077  
Email: sales@diviotec.com  
www.diviotec.com

#### **AIoT Cloud Corp.**

#### **NEXSEC Incorporated**

13F, No.922, Zhongzheng Rd.,  
Zhonghe District,  
New Taipei City, 23586, Taiwan, R.O.C.  
Tel: +886-2-8226-7786  
Fax: +886-2-8226-7782  
Email: alantsai@aiotcloud.net  
www.aiotcloud.dev

#### **EMBOX Technology Co., Ltd.**

13F, No.916, Zhongzheng Rd.,  
Zhonghe District,  
New Taipei City, 23586, Taiwan, R.O.C.  
Tel: +886-2-8226-7786  
Fax: +886-2-8226-7782  
Email: info@embux.com  
www.embux.com

#### **TMR Technology Corp.**

13F, No.916, Zhongzheng Rd.,  
Zhonghe District,  
New Taipei City, 23586, Taiwan, R.O.C.  
Tel: +886-2-8226-7786  
Fax: +886-2-8226-7782  
Email: services@tmrtek.com  
www.tmrtek.com

## China

### **NEXSEC Incorporated**

201, Floor 2, Unit 2, Building 15, Yard 3,  
Gaolizhang Road, Haidian District,  
Beijing, 100094, China  
Tel: +86-10-5704-2680  
Fax: +86-10-5704-2681  
Email: marketing@nexsec.cn  
www.nexcom.cn

### **NEXCOM Shanghai**

Room 406-407, Building C, No 154, Lane 953,  
Jianchuan Road, Minhang District,  
Shanghai, 201108, China  
Tel: +86-21-5278-5868  
Fax: +86-21-3251-6358  
Email: sales@nexcom.cn  
www.nexcom.cn

### **NEXCOM Surveillance Technology Corp.**

Floor 8, Building B3, Xiufeng Industrial Zone,  
GanKeng Community, Buji Street,  
LongGang District,  
ShenZhen, 518112, China  
Tel: +86-755-8364-7768  
Fax: +86-755-8364-7738  
Email: steveyang@nexcom.com.tw  
www.nexcom.cn

## **NEXGOL Chongqing**

1st Building No.999,  
Star Boulevard, Yongchuan Dist,  
Chongqing City, 402160, China  
Tel: +86-23-4960-9080  
Fax: +86-23-4966-5855  
Email: sales@nexgol.com.cn  
www.nexcom.cn

## **Beijing NexGemo Technology Co.,Ltd.**

Room 205, No.1, Fazhan Rd.,  
Beijing International Information Industry Base,  
Changping District,  
Beijing, 102206, China  
Tel: +86-10-8072-2025  
Fax: +86-10-8072-2022  
Email: sales@nexgemo.cn  
www.nexgemo.cn

## Japan

### **NEXCOM Japan**

9F, Tamachi Hara Bldg.,  
4-11-5, Shiba Minato-ku,  
Tokyo, 108-0014, Japan  
Tel: +81-3-5419-7830  
Fax: +81-3-5419-7832  
Email: sales@nexcom-jp.com  
www.nexcom-jp.com

## America

### **USA NEXCOM USA**

46665 Fremont Blvd.,  
Fremont CA 94538, USA  
Tel: +1-510-656-2248  
Fax: +1-510-656-2158  
Email: sales@nexcom.com  
www.nexcomusa.com

## Package Contents

Before continuing, verify that the package that you received is complete. Your CPS 50-N01 package should have all the items listed in the following table.

Item	Part Number	Description	Qty
1	50311F0330X00	ROUND HEAD SCREW LONG FEI:P2x3 ISO+NYLON P2x3 NI NYLOK	2
2	50311F0295X00	FLAT HEAD SCREW LONG FEI:F2x4 NYLOK NIGP F2x4 NIGP NYLOK	2
3	5060900226X00	MINI PCIe BRACKET CHYUAN-JYH 29x30x2.1mm SPCC t=1.0mm NI	1
4	4NCPM00302X00	(T)TERMINAL BLOCKS 3P PHOENIX CONTACT:1777992 5.08mm MALE DIP GREEN	1
5	5061600245X00	WASHER KANGYANG:TW-320-01 10.4x6.4mm T=1mm NYLON BLACK	12

## Ordering Information

The following information below provides ordering information for CPS 50-N01.

### **CPS 50-N01 (P/N: 10JC0005000X0)**

- NXP i.MX8M Plus Cortex®-A53 quad core 1.6 GHz fanless system, 2GB LPDDR4, 32GB eMMC
- 24V, 60W AC to DC power adapter w/o power cord (P/N: 7400060054X00)

# CHAPTER 1: PRODUCT INTRODUCTION

## CPS 50-N01 Overview



### Key Features

- NXP i.MX8M Plus Cortex®-A53 quad core processor
- 1 x HDMI
- 1 x USB 3.0, 1 x USB 2.0
- 1 x COM
- 2 x GbE LAN ports
- 1 x Full-size mini-PCIe for optional Wi-Fi/BT/4G LTE (PCIe 3.0, USB 2.0, SIM)
- 1 x Internal M.2 2230 Key E (USB 2.0, SDIO, UART)
- Modular rear I/O design for easy customization
- Support 9~30V DC input

## CPS 50-N01 Hardware Specifications

### CPU Support

- NXP i.MX8M Plus Cortex®-A53 quad core 1.6 GHz

### Main Memory

- Onboard LPDDR4 2 GB, 4000MT/s memory

### Display Option

- 1 x HDMI, resolution up to 3840 x 2160 @30Hz, 1920 x 1080 @60Hz

### LED System Indicators

- Top: 3 x Green wireless network status LED
- Front: 1 x Green power LED, 1 x Green SW programmable LED

### I/O Interface - Front

- ATX power on/off switch
- 1 x HDMI
- 2 x RJ45 for GbE LAN
- 1 x USB 3.0 Type A port (900 mA), 1 x USB 2.0 Type A port (500 mA)
- 1 x DB9 for RS-232/422/485, select by SW (TX, RX, CTS, RTS 4 wire only)
- 1 x 3-pin terminal block, support 9-30VDC input
- 2 x Antenna hole for optional Wi-Fi/4G/LTE antenna

### I/O Interface - Rear

- 4 x Antenna hole for optional Wi-Fi/4G/LTE antenna

### I/O Interface - Internal

- 1 x MIPI-CSI connector
- 1 x 4-lane MIPI-DSI connector (Either one with LVDS connector, BOM option)
- 1 x LVDS connector 24-bit LVDS, backlight power: 12V, max 1A
- 1 x Touch connector
- 1 x Debug connector for console use

### Storage Device

- 1 x Onboard 32 GB EMMC
- 1 x Internal Micro SD slot

### Expansion Slot/Storage

- 1 x Full-size mini-PCIe for optional Wi-Fi/BT/4G LTE (PCIe 3.0, USB 2.0, SIM), support SIM card holder onboard
- 1 x M.2 2230 Key E (USB 2.0, SDIO, UART)

### Power Requirements

- Power input: 9-30V DC input

### Supported OS

- Primary: Linux 5.4.70\_2.3.3 Yocto Project 3.0 (Zeus)
- Secondary: Ubuntu 20.04 LTS



## Dimensions

- 162mm (W) x 150mm (D) x 26mm (H) w/o wall mount bracket
- 186mm (W) x 150mm (D) x 26mm (H) w/ wall mount bracket

## Construction

- Metal chassis with fanless design

## Environment

- Operating temperature
  - Ambient temperature: -20°C~70 °C  
(according to IEC60068-2-1, IEC60068-2-2, IEC60068-2-14)
- Storage temperature: -20°C to 85°C
- Relative humidity: 10% to 90% (non-condensing)
- Shock protection
  - EMMC/M.2: 50G@wall mount, half sine, 11ms (operation), IEC60068-2-27
- Vibration protection with EMMC/ M.2 condition:
  - Random: 2Grms@5~500 Hz, IEC60068-2-64
  - Sinusoidal: 2Grms@5~500 Hz, IEC60068-2-6

# Knowing Your CPS 50-N01

## Front Panel

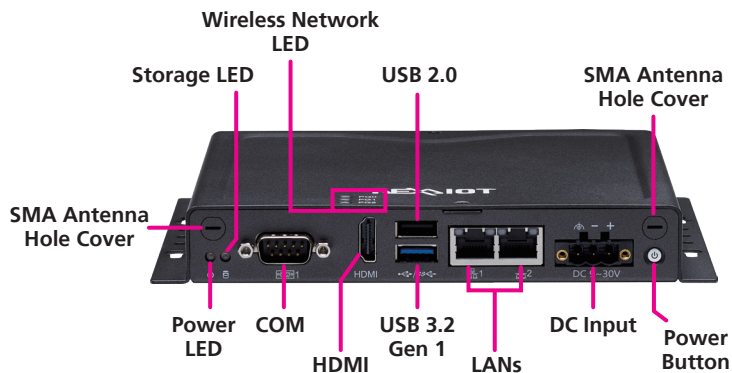

## Rear Panel



### SMA Antenna Hole Cover

Used to install the external antennas. (4 x 5G NR, 2 x WiFi)

### Power LED

Indicates the power status. (Programmable by S/W, optional GPIO)

### Storage LED

Indicates the storage device status. (Programmable by S/W, optional GPIO)

### COM Port

Used to connect a RS-232/422/485 serial device (selected by S/W).

### Wireless Network LED

Indicates the wireless network status (GPIO programmable).

### HDMI

Used to connect HDMI interface display (resolution up to 3840 x 2160 @30Hz, 1920x1080 @60Hz).

### USB 3.2 Gen 1

Used to connect the system with a USB 3.2 Gen 1/2.0 device.

### USB 2.0

Used to connect the system with a USB 2.0/1.1 device.

### LANs

Used to connect the system to a local area network.

### DC Input

Used to plug a DC power cord (9~30V DC, default 24V, 60W).

### Power Button

Press to power on/off the system.

# CPS 50-N01 Mechanical Dimensions

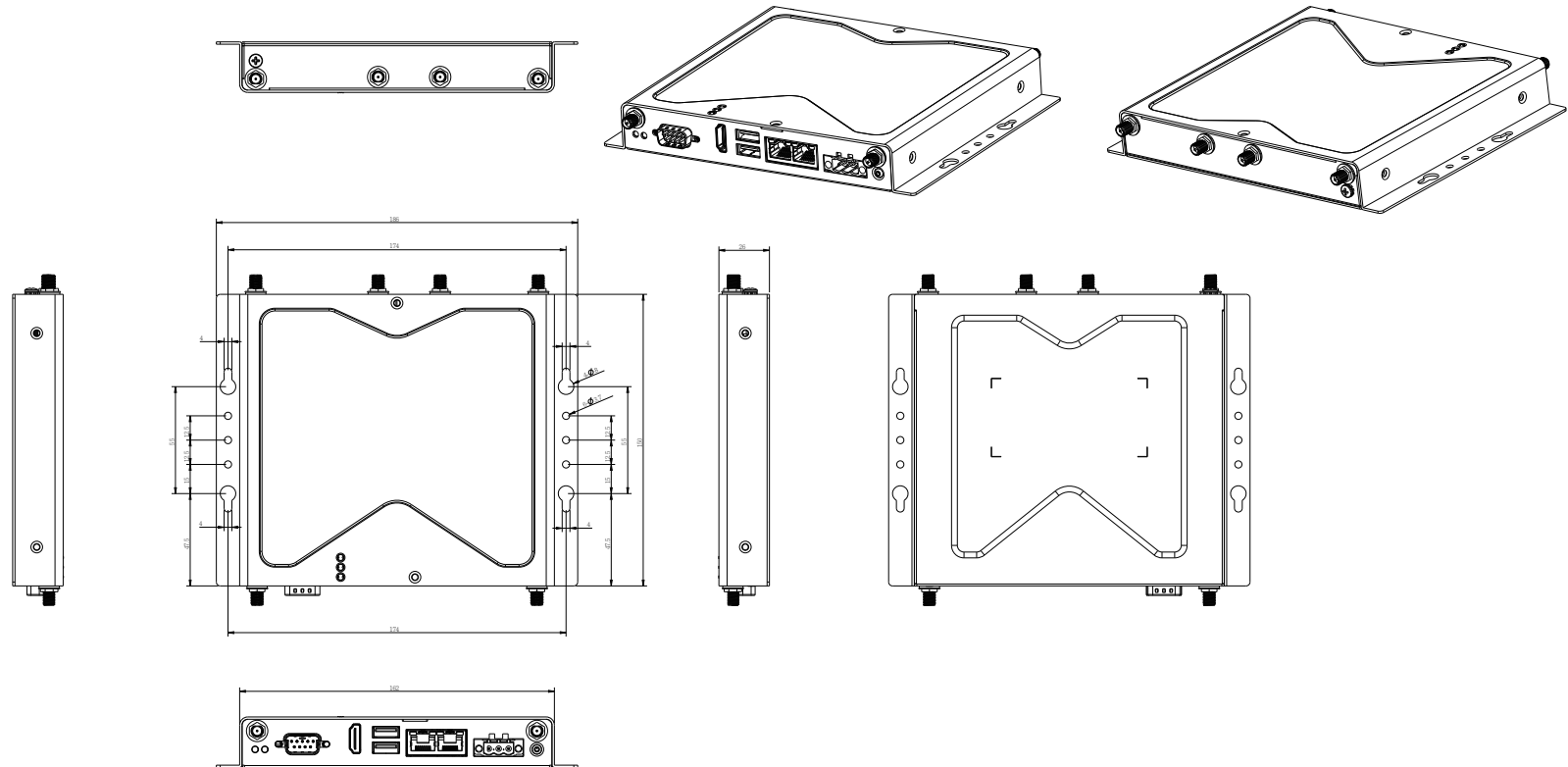

## CHAPTER 2: JUMPERS AND CONNECTORS

This chapter describes how to set the jumpers and connectors on the CPS 50-N01 Series motherboard.

### Before You Begin

- Ensure you have a stable, clean working environment. Dust and dirt can get into components and cause a malfunction. Use containers to keep small components separated.
- Adequate lighting and proper tools can prevent you from accidentally damaging the internal components. Most of the procedures that follow require only a few simple tools, including the following:
  - A Philips screwdriver
  - A flat-tipped screwdriver
  - A set of jewelers screwdrivers
  - A grounding strap
  - An anti-static pad
- Using your fingers can disconnect most of the connections. It is recommended that you do not use needle-nosed pliers to disconnect connections as these can damage the soft metal or plastic parts of the connectors.
- Before working on internal components, make sure that the power is off. Ground yourself before touching any internal components, by touching a metal object. Static electricity can damage many of the electronic components. Humid environments tend to have less static electricity than

dry environments. A grounding strap is warranted whenever danger of static electricity exists.

### Precautions

Computer components and electronic circuit boards can be damaged by discharges of static electricity. Working on computers that are still connected to a power supply can be extremely dangerous.

Follow the guidelines below to avoid damage to your computer or yourself:

- Always disconnect the unit from the power outlet whenever you are working inside the case.
- If possible, wear a grounded wrist strap when you are working inside the computer case. Alternatively, discharge any static electricity by touching the bare metal chassis of the unit case, or the bare metal body of any other grounded appliance.
- Hold electronic circuit boards by the edges only. Do not touch the components on the board unless it is necessary to do so. Don't flex or stress the circuit board.
- Leave all components inside the static-proof packaging that they shipped with until they are ready for installation.
- Use correct screws and do not over tighten screws.

## Jumper Settings

A jumper is the simplest kind of electric switch. It consists of two metal pins and a cap. When setting the jumpers, ensure that the jumper caps are placed on the correct pins. When the jumper cap is placed on both pins, the jumper is short. If you remove the jumper cap, or place the jumper cap on just one pin, the jumper is open.

Refer to the illustrations below for examples of what the 2-pin and 3-pin jumpers look like when they are short (on) and open (off).

Two-Pin Jumpers: Open (Left) and Short (Right)

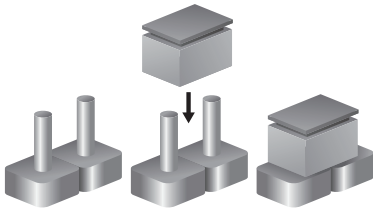

Three-Pin Jumpers: Pins 1 and 2 are Short

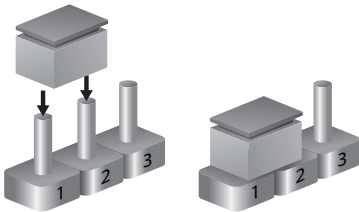

## Locations of the Jumpers and Connectors for CPS 50-N01

The figure below is the top view of the main board used in CPS 50-N01. It shows the locations of the jumpers and connectors.

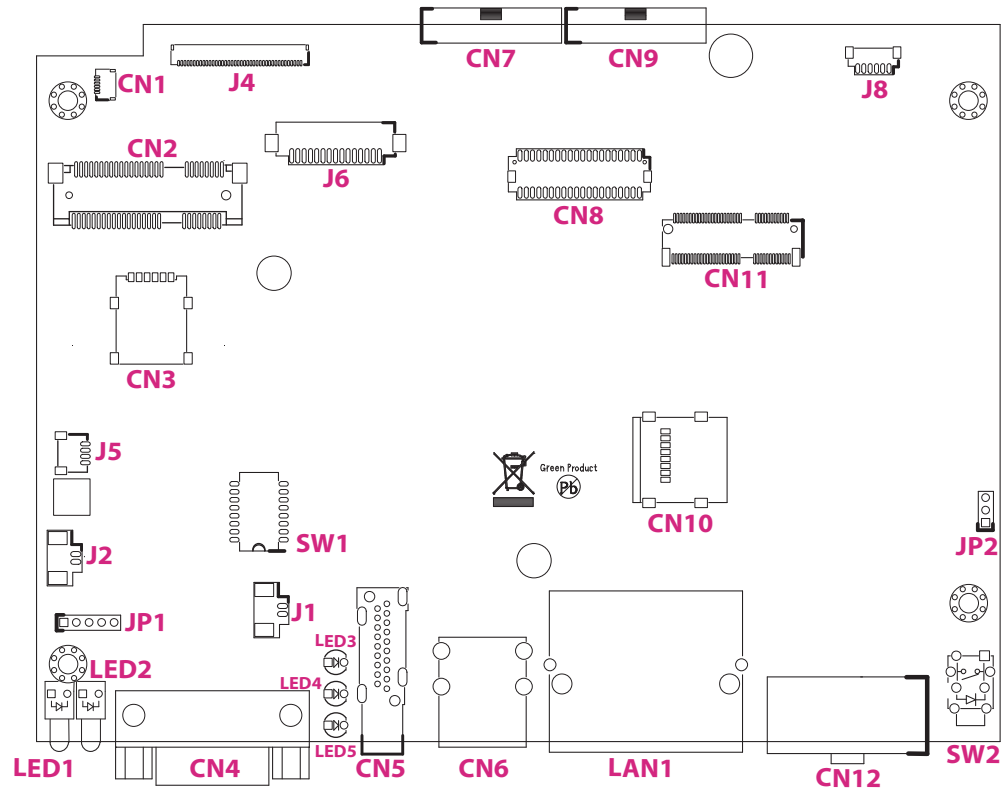

# Jumps

## Power Mode Select

Connector type: 1x3 3-pin header

Connector location: JP2



Pin	Settings
1-2 Short	Normal Mode
2-3 Short	Direct Power On

Pin	Definition
1	X
2	VDC_IN
3	VSYS_5V_EN

## Connector Pin Definitions

### External I/O Interfaces

#### RS232/485/422 Connector

Connector type: D-Sub 9-pin male connector

Connector location: CN4

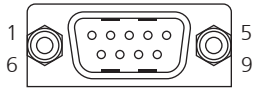

##### RS232

Pin	Definition	Pin	Definition
1	COM_DCD_CN	2	COM_RXD_CN
3	COM_TXD_CN	4	COM_DTR_CN
5	GND	6	COM_DSR_CN
7	COM_RTS_CN	8	COM_CTS_CN
9	COM_RI_CN	10	

##### RS422

##### RS485

Pin	Definition	Pin	Definition
1	TX-	1	DATA-
2	TX+	2	DATA+
3	RX-		
4	RX+		

#### HDMI Connector

Connector type: HDMI port

Connector location: CN5

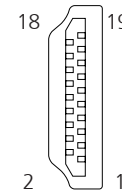

Pin	Definition	Pin	Definition
1	HDMI_TXP2_CN	2	GND
3	HDMI_TXN2_CN	4	HDMI_TXP1_CN
5	GND	6	HDMI_TXN1_CN
7	HDMI_TXP0_CN	8	GND
9	HDMI_TXN0_CN	10	HDMI_CLKP_CN
11	GND	12	HDMI_CLKN_CN
13	HDMI_CEC_CN	14	HDMI_Utility_CN
15	HDMI_DDC_SCL_CN	16	HDMI_DDC_SDA_CN
17	GND	18	HDMI_5V_CN
19	HDMI_HPD_CN	20	



## USB Ports

Connector type: USB 2.0 (Top) and USB 3.0 (Bottom) Type A Ports

Connector location: CN6

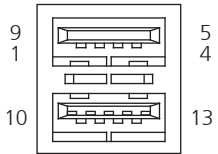

Pin	Definition	Pin	Definition
1	USB1_VBUS_CN	2	USB1_DN_CN
3	USB1_DP_CN	4	GND
5	USB1_RXN_CN	6	USB1_RXP_CN
7	GND	8	USB1_TXN_CN
9	USB1_TXP_CN	10	USB2_VBUS_CN
11	USBHOST_D1_N_CN	12	USBHOST_D1_P_CN
13	GND		

## DC Power Input

Connector type: 3-pin terminal block  
Connector location: CN12

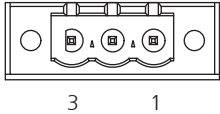

Pin	Definition
1	Power VIN
2	GND
3	Chassis GND

## Functional Ground Isolation

When connecting the power to the terminal block connector on the system, ensure the ground pin (see the image below) on the connector is connected to a grounding stripe.



## LAN Ports

Connector type: RJ45 with LEDs  
 Connector location: LAN1A

Connector type: RJ45 with LEDs  
 Connector location: LAN1B

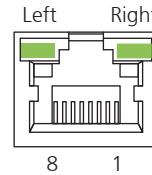
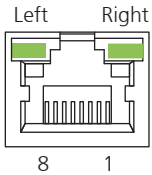

Speed Status	Left LED	Right LED
100M	Steady Green	Blinks green when data is being transferred
1G	Blinks green when data is being transferred	Off

Speed Status	Left LED	Right LED
100M	Steady Green	Blinks green when data is being transferred
1G	Blinks green when data is being transferred	Off

Pin	Definition	Pin	Definition
A1	ETH1_TRX0_P	A2	ETH1_TRX0_N
A3	ETH1_TRX1_P	A4	ETH1_TRX1_N
A5	VDD_3V3	A6	GND
A7	ETH1_TRX2_P	A8	ETH1_TRX2_N
A9	ETH1_TRX3_P	A10	ETH1_TRX3_N
A11	E1_10M_100M_Link/Active	A12	E1_LED1/CFGLD00
A13	E1_1GB_Link/Active	A14	E1_LED2/CFGLD01

Pin	Definition	Pin	Definition
B1	ETH_TRX0_P	B2	ETH_TRX0_N
B3	ETH_TRX1_P	B4	ETH_TRX1_N
B5	VDD_3V3	B6	GND
B7	ETH_TRX2_P	B8	ETH_TRX2_N
B9	ETH_TRX3_P	B10	ETH_TRX3_N
B11	10M_100M_Link/Active	B12	LED1/CFGLD00
B13	1GB_Link/Active	B14	LED2/CFGLD01

## Power Button

Connector location: SW2

By default, short press to turn on or 6 seconds to turn off the system. See jumper [JP2](#) to select the desired power mode.



Pin	Definition	Pin	Definition
1	VDC_IN	2	PWR_OFF_GPIO
3	PWR_OFF_GPIO	4	VDC_IN
A1	VDD_3V3	C1	GND
MH1	GND_Chassis	MH2	GND_Chassis

## Internal Connectors

### DSI Touch Connector

Connector type: 1x6 6-pin header  
 Connector location: CN1

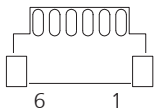

Pin	Definition	Pin	Definition
1	GND	2	VEXT_3V3
3	DSI_TP_INT	4	DSI_TP_RST
5	DSI_TP_I2C_SCL	6	DSI_TP_I2C_SDA

### SIM Card Connector

Connector type: SIM card slot and 2x3 6-pin header  
 Connector location: CN3

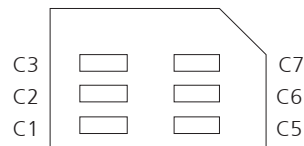

Pin	Definition	Pin	Definition
C1	VCCP_USIM	C2	UIM_REST
C3	UIM_CLK	C5	GND
C6	UIM_VPP	C7	UIM_DATA

## Mini-PCIe Slot

Connector location: CN2

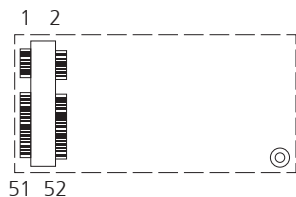

Pin	Definition	Pin	Definition
1	NC	2	VCC3V3_MPCIE
3	NC	4	GND
5	NC	6	NC
7	PCIE_nCLKREQ	8	VCCP_USIM
9	GND	10	UIM_DATA
11	REF_CLKN_CN	12	UIM_CLK
13	REF_CLKP_CN	14	UIM_RESET
15	GND	16	UIM_VPP
17	NC	18	GND
19	NC	20	MPCIE_W_DIS
21	GND	22	MPCIE_RSTB
23	PCIE_RXN	24	VCC3V3_MPCIE
25	PCIE_RXP	26	GND

Pin	Definition	Pin	Definition
27	GND	28	NC
29	GND	30	NC
31	PCIE_TXN	32	NC
33	PCIE_TXP	34	GND
35	GND	36	USB_DN-MPCIE
37	GND	38	USB_DP-MPCIE
39	VCC3V3_MPCIE	40	GND
41	VCC3V3_MPCIE	42	NC
43	GND	44	NC
45	NC	46	NC
47	NC	48	NC
49	NC	50	GND
51	NC	52	VCC3V3_MPCIE

## Board to Board Connector

Connector type: SIM card slot and 2x3 6-pin header

Connector location: CN7

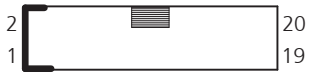

Pin	Definition	Pin	Definition
1	VCC_5V_IO	2	GND
3	USB_IO1_DN	4	USB_IO2_DP
5	USB_IO1_DP	6	USB_IO2_DN
7	GND	8	VCC_5V_IO
9	USB3_SSTX-	10	UIO1_GPIO2
11	USB3_SSTX+	12	UIO1_GPIO4
13	VCC_5V_IO	14	GND
15	USB_IO3_DN	16	USB3_SSRX+
17	USB_IO3_DP	18	USB3_SSRX-
19	GND	20	VCC_5V_IO

## Board to Board Connector

Connector type: SIM card slot and 2x3 6-pin header

Connector location: CN9

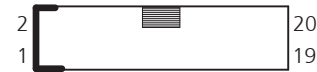

Pin	Definition	Pin	Definition
1	VCC_5V_IO	2	GND
3	COM2_TXD	4	COM4_TXD
5	COM2_RXD	6	COM4_RXD
7	UIO2_GPIO5	8	UIO2_GPIO6
9	UIO2_GPIO7	10	UIO2_GPIO8
11	UIO2_GPIO9	12	UIO2_GPIO10
13	UIO2_GPIO11	14	UIO2_GPIO12
15	CAN1_TX	16	I2C2_SDA
17	CAN1_RX	18	I2C2_SCL
19	VEXT_3V3	20	GND

## LVDS Connector

Connector location: CN8

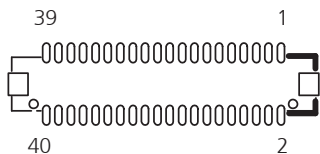

Pin	Definition	Pin	Definition
1	GND	2	LVDS1_TX0_N1
3	LVDS0_TX0_N1	4	LVDS1_TX0_P1
5	LVDS0_TX0_P1	6	GND
7	GND	8	LVDS1_TX1_N1
9	LVDS0_TX1_N1	10	LVDS1_TX1_P1
11	LVDS0_TX1_P1	12	GND
13	GND	14	LVDS1_TX2_N1
15	LVDS0_TX2_N1	16	LVDS1_TX2_P1
17	LVDS0_TX2_P1	18	GND
19	GND	20	LVDS1_CLK_N1

Pin	Definition	Pin	Definition
21	LVDS0_CLK_N1	22	LVDS1_CLK_P1
23	LVDS0_CLK_P1	24	GND
25	GND	26	LVDS1_TX3_N1
27	LVDS0_TX3_N1	28	LVDS1_TX3_P1
29	LVDS0_TX3_P1	30	GND
31	GND	32	LVDS_LED_PWR
33	LVDS_VDD	34	LVDS_LED_PWR
35	LVDS_VDD	36	LVDS_LED_PWM
37	LVDS_VDD	38	LVDS_LED_EN
39	GND	40	GND



## Micro SD Card Slot

Connector type: Standard Micro SD Card Slot

Connector location: CN10

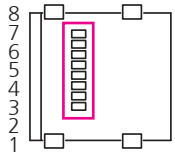

Pin	Definition	Pin	Definition
1	SD2_DATA2	2	SD2_DATA3
3	SD2_CMD	4	VSD_3V3
5	SD2_CLK	6	GND
7	SD2_DATA0	8	SD2_DATA1

## M.2 Connector (Key E 2330)

Connector location: CN11

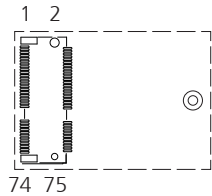

Pin	Definition	Pin	Definition
1	CONFIG_3	2	VCC_3V3_IO
3	GND	4	VCC_3V3_IO
5	GND	6	POWER_OFF#
7	USB_IO2_DP_CN	8	W_DIS1#
9	USB_IO2_DN_CN	10	NC
21	CONFIG_0	20	NC
23	NC	22	NC
25	NC	24	NC
27	GND	26	W_DIS2#_1V8
29	USB3_SSRX-	28	NC
31	USB3_SSRX+	30	USIM1_RESET
33	GND	32	USIM1_CLK
35	USB3_SSTX-	34	USIM1_DATA
37	USB3_SSTX+	36	USIM1_VDD
39	GND	38	NC
41	NC	40	NC
43	NC	42	NC

Pin	Definition	Pin	Definition
45	GND	44	NC
47	NC	46	NC
49	NC	48	NC
51	GND	50	NC
53	NC	52	NC
55	NC	54	NC
57	GND	56	NC
59	NC	58	NC
61	NC	60	NC
63	NC	62	NC
65	NC	64	NC
67	RESET#_1V8	66	USIM1_DET
69	CONFIG_1	68	NC
71	GND	70	VCC_3V3_IO
73	GND	72	VCC_3V3_IO
75	CONFIG_2	74	VCC_3V3_IO

## Battery Connector

Connector type: 1x2 2-pin header

Connector location: J1

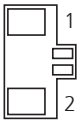

Pin	Definition	Pin	Definition
1	GND	2	VBAT

## MIC Connector

Connector type: 1x2 2-pin header

Connector location: J2

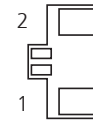

Pin	Definition	Pin	Definition
1	MICON_CON	2	MICOP_CON

## MIPI-DSI Connector

Connector type: 1x40 40-pin header

Connector location: J4

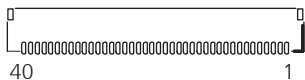

Pin	Definition	Pin	Definition
1	DSI_LED-	2	DSI_LED-
3	DSI_LED+	4	GND
5	GND	6	DSI_DN0
7	DSI_DP0	8	GND
9	DSI_DN1	10	DSI_DP1
11	GND	12	DSI_CKN
13	DSI_CKP	14	GND
15	DSI_DN2	16	DSI_DP2
17	GND	18	DSI_DN3
19	DSI_DP3	20	GND

Pin	Definition	Pin	Definition
21	DSI_IOVCC(VEXT_3V3)	22	DSI_IOVCC(VEXT_3V3)
23	GND	24	GND
25	X	26	X
27	DSI_RESET	28	X
29	X	30	DSI_VCI(VEXT_3V3)
31	DSI_VCI(VEXT_3V3)	32	X
33	X	34	X
35	X	36	X
37	X	38	X
39	X	40	X

## UART2 Connector

Connector type: 1x5 5-pin header

Connector location: J5

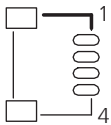

Pin	Definition	Pin	Definition
1	GND	2	UART2_TXD
3	UART2_RXD	4	VDD_3V3

## MIPI-CSI Connector

Connector type: 1x15 15-pin header

Connector location: J6

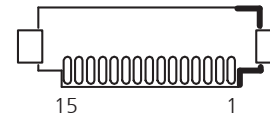

Pin	Definition	Pin	Definition
1	GND	2	CAM_D0_N
3	CAM_D0_P	4	GND
5	CAM_D1_N	6	CAM_D0_P
7	GND	8	CAM_CK_N
9	CAM_CK_P	10	GND
11	CAM_PWR_EN	12	CAM_RESET
13	CAM_SCL	14	CAM_SDA
15	CAM_3V3		

## LVDS Touch Connector

Connector type: 1x6 6-pin header

Connector location: J8

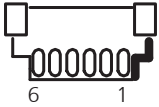

Pin	Definition	Pin	Definition
1	GND	2	RST_TP
3	VDD_TP (VEXT_3V3)	4	INT_TP
5	USB_TP_D1_P	6	USB_TP_D1_N

# Block Diagram

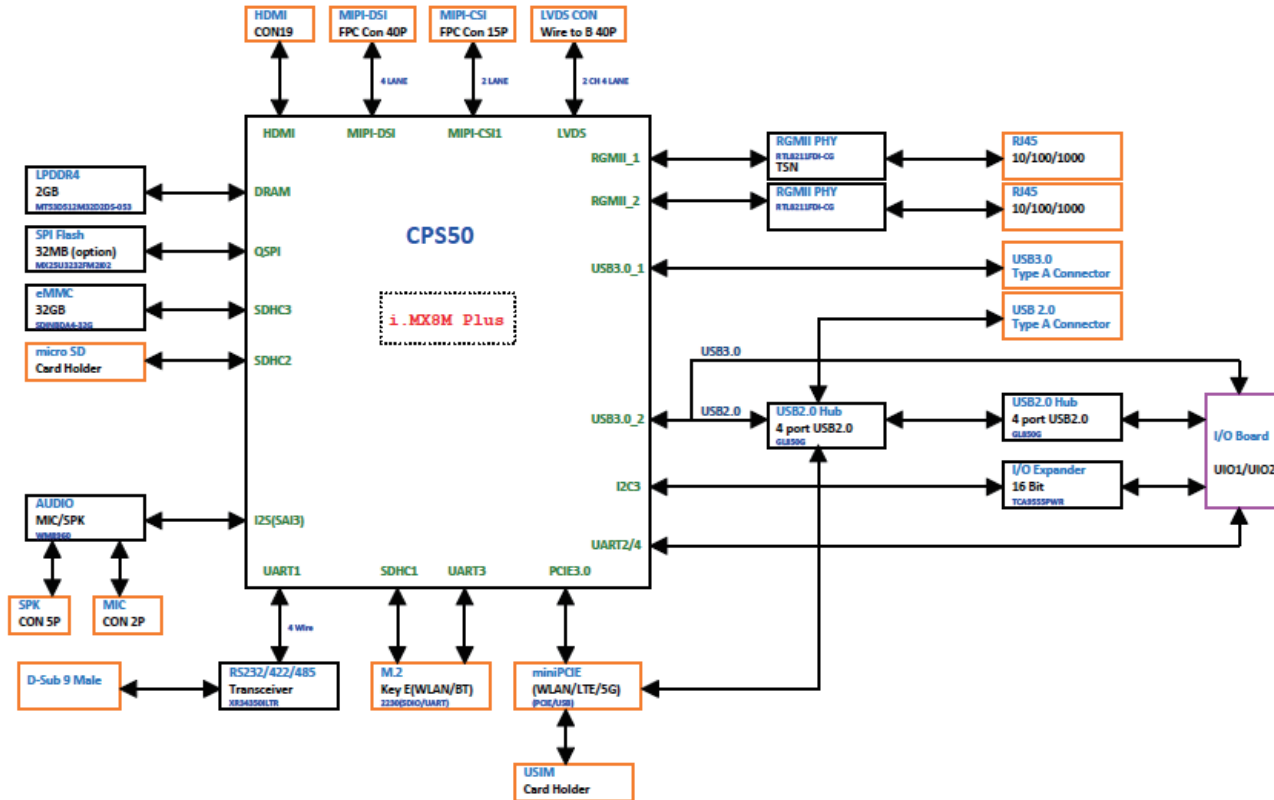

## CHAPTER 3: SYSTEM SETUP

### Removing the Chassis Cover



Prior to removing the chassis cover, make sure the unit's power is off and disconnected from the power sources to prevent electric shock or system damage.

1. Remove the six mounting screws around the chassis cover. There are two screws each on the top and on the sides.

2. With the screws removed, lift up the cover and remove it from the chassis.





## Installing a Micro SD Card

1. Locate the Micro SD card slot on the main board. Notice that the Micro SD cover is secured to the main board.
2. Pull the Micro SD card slot cover to the right (1), lift it up (2) to open the Micro SD cover.

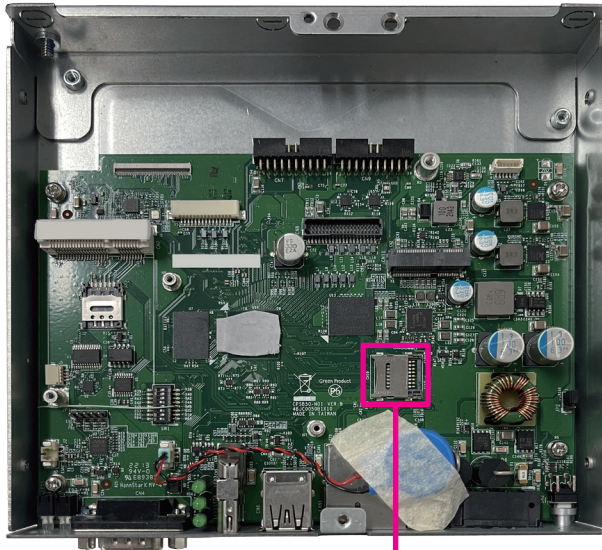

Micro SD Card Slot

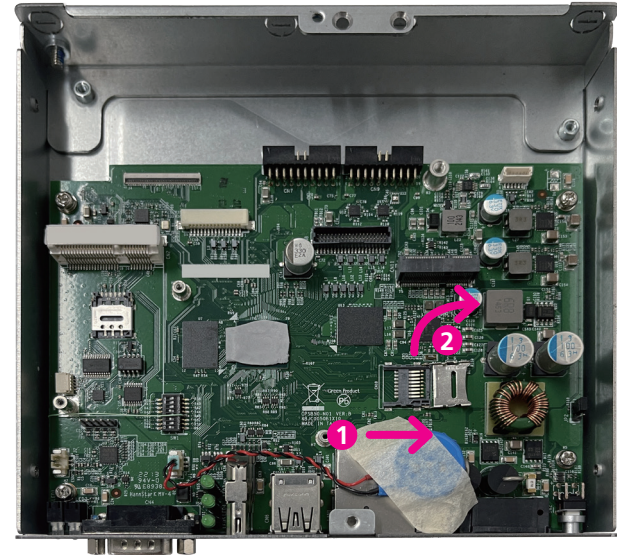

3. Insert a Micro SD card into the Micro SD card slot.

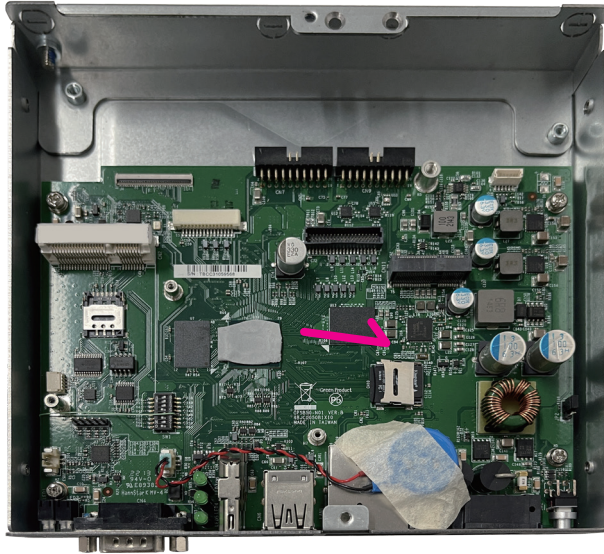

4. Secure the Micro SD card to the original position.

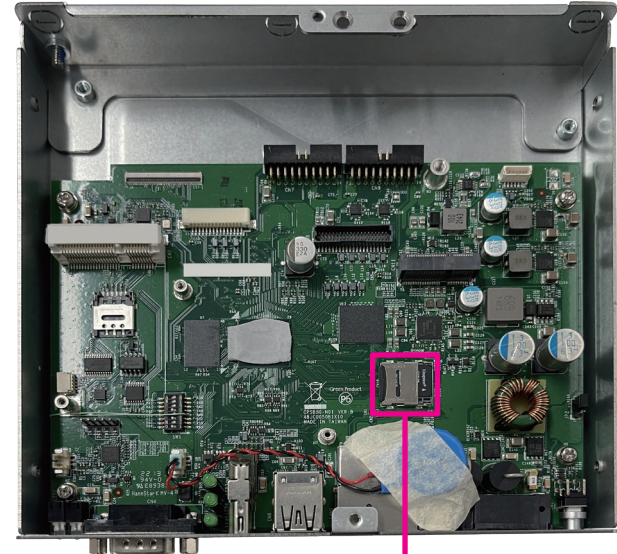

Secure the  
Micro SD Card

## Installing a WLAN/5G/4G LTE Module (Full-size mini-PCle)

1. Locate the mini-PCle slot on the board.
2. Insert the module into the mini-PCle slot at a 45-degree angle until the gold-plated connector on the edge of the module completely disappears into the slot.

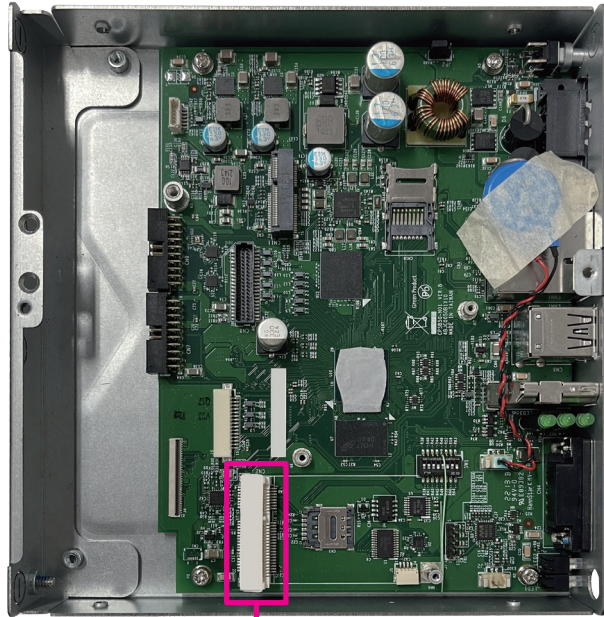

Mini-PCle Socket



3. Push the module down and secure it with a mounting screw.



Mounting Screw

## Installing a WLAN/ Bluetooth Mini-PCle Module (Half-size mini-PCle)

1. Align the wireless LAN module to the module bracket and secure both together with screws.
2. Insert the wireless LAN module into the mini-PCle slot at 45-degree angle until the gold-plated connector on the edge of the module completely disappears inside the slot (1). Push the module down and then secure it with a mounting screw (2).

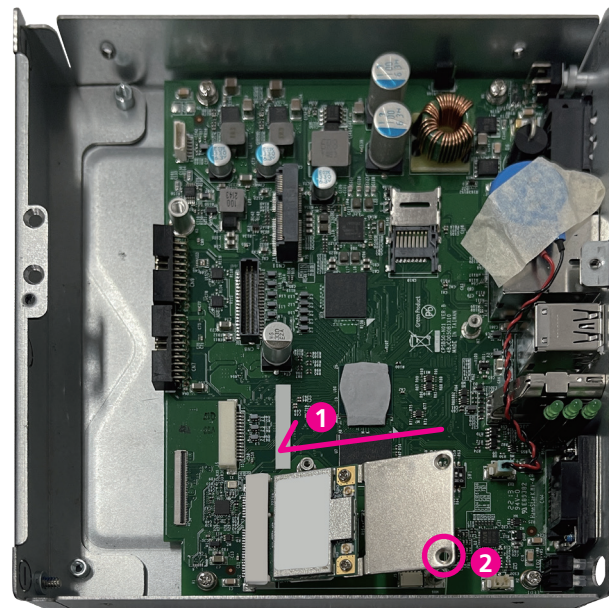
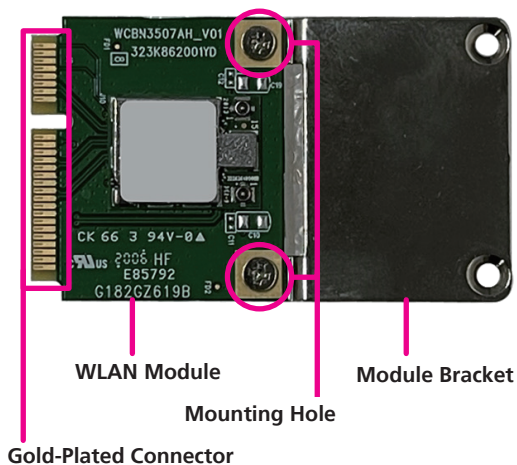

## Installing a M.2 Key E Module (2230)

1. Locate the M.2 Key E slot on the main board.
2. Insert the M.2 Key E module into the M.2 Key E slot at a 45 degrees angle until the gold-plated connector on the edge of the module completely disappears inside the slot.

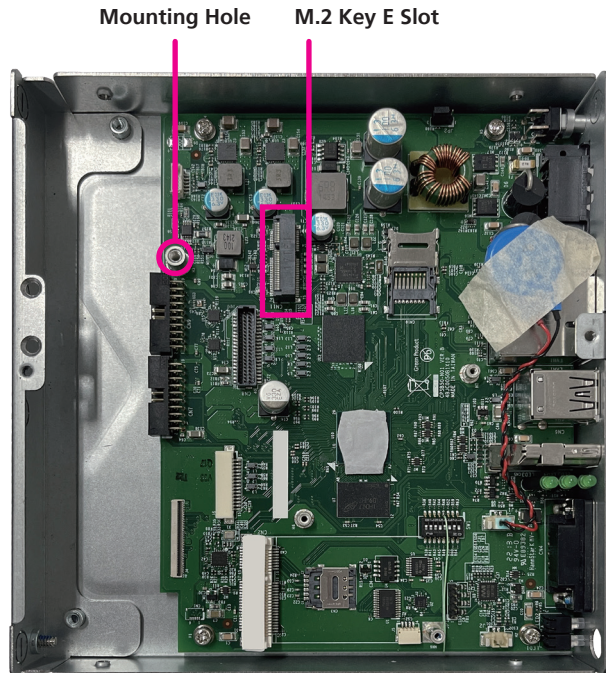

3. Push the M.2 Key E module down and fasten an M.2 mounting screw into the mounting hole to secure the module.

#### Secure the M.2 Key E Module



## Installing a Nano SIM Card

1. Locate the nano SIM card holder on the board. Notice that nano SIM card cover is secured to the board.
2. Pull the nano SIM card cover to the left (1), and lift it up (2) to open the nano SIM card cover.

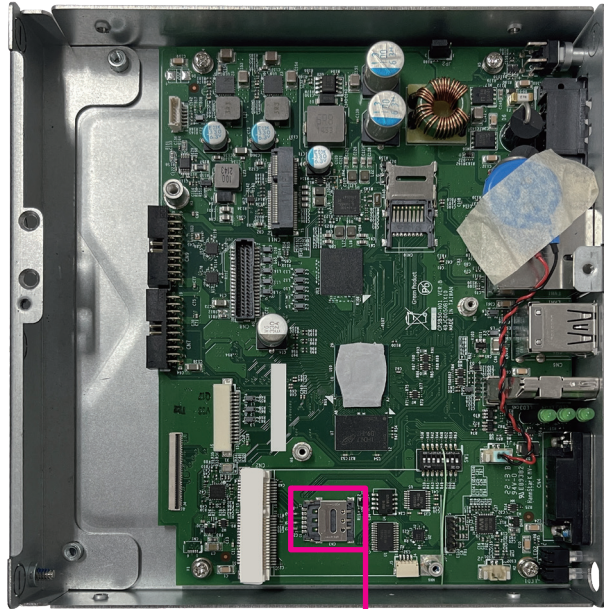

Nano SIM Card Slot

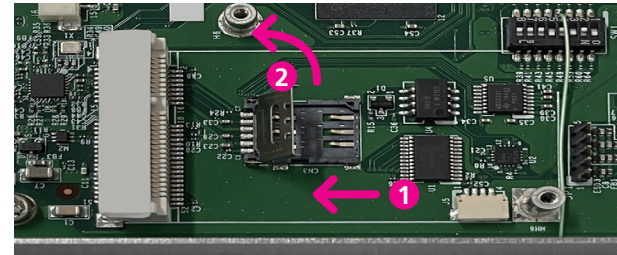

3. Insert the nano SIM card into the nano SIM card slot.

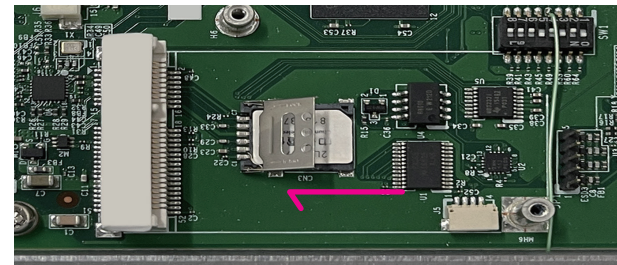



4. Push the nano SIM-card cover down, and pull it to the right. Secure the nano SIM card to the original position.

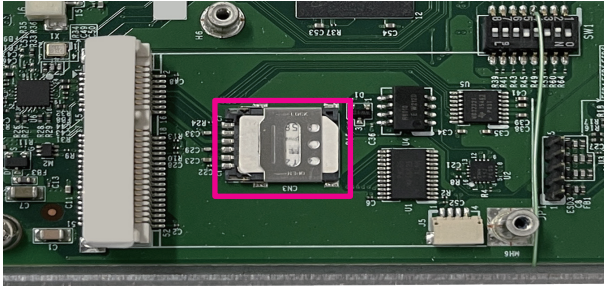

## Installing an Antenna



Note: Please remove the gaskets (ring 1 and ring 2) on the SMA antenna jack first.

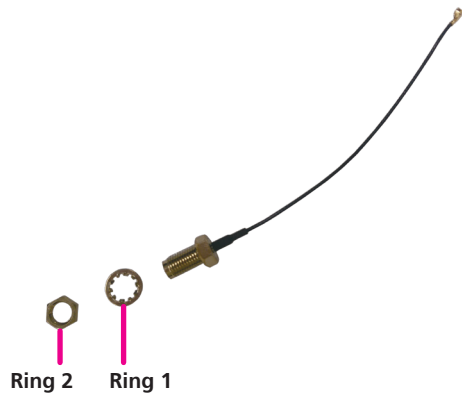

1. Remove the antenna cover located on the front panel/rear panel.



2. Insert the SMA antenna jack end of the cable through the antenna hole, and insert the two rings (ring 1 and ring 2) and two washer back to the antenna jack.



Note: Refer to the image below for the gasket and washer installation sequence.

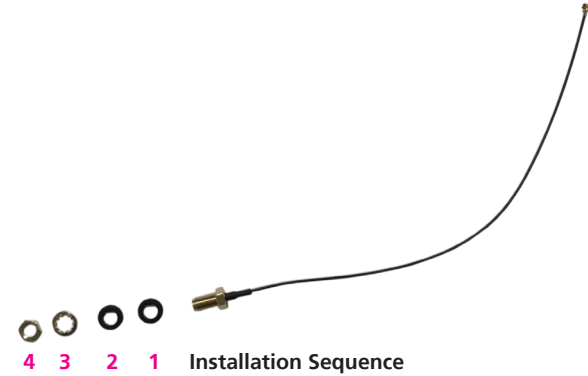
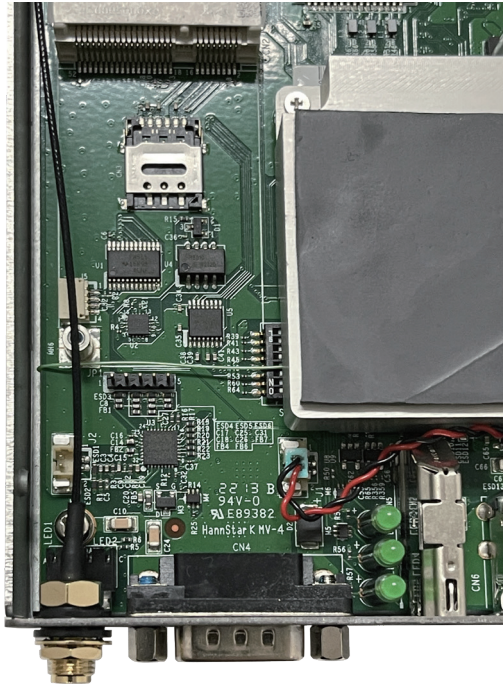



Note: When installing the Wi-Fi or 4G LTE antennas, make sure the washer (P/N: 5061600245X00) are fitted onto the antenna connector, one on each side as shown below.

3. Attach the RF cable onto the module.
4. Connect the external antenna to the antenna jack.

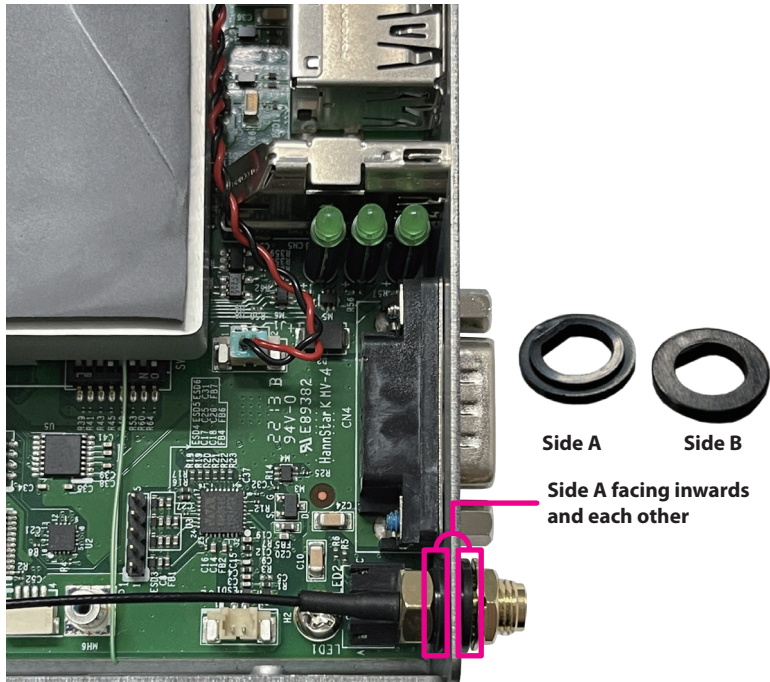

# CHAPTER 4: SOFTWARE FUNCTIONALITY

## Build Yocto Linux, Ubuntu, or Android image for CPS50

### Yocto Linux

Please refer to NXP i.MX Yocto Project User's Guide:

[https://www.nxp.com/docs/en/user-guide/IMX\\_YOCTO\\_PROJECT\\_USERS\\_GUIDE.pdf](https://www.nxp.com/docs/en/user-guide/IMX_YOCTO_PROJECT_USERS_GUIDE.pdf)

```
$ tar xvf ~/imx-yocto-bsp-5.4.70_2.3.3.tar.gz
$ cd ~/imx-yocto-bsp-5.4.70_2.3.3/
$ DISTRO=fsl-imx-xwayland MACHINE=imx8mpdevk source imx-setup-
release.sh -b imx8mpdevk_fsl-imx-xwayland
$ bitbake imx-image-full
```

### Ubuntu

1. **Build the Yocto Linux first**
2. **Download the Ubuntu rootfs**

```
$ cd ~
$ wget http://cdimage.ubuntu.com/ubuntu-base/releases/20.04.4/
release/ubuntu-base-20.04.4-base-arm64.tar.gz
$ mkdir ubuntu-rootfs
$ tar -xvf ubuntu-base-20.04.4-base-arm64.tar.gz -C ubuntu-rootfs/
$ cd ubuntu-rootfs/
```

3. **Install the qemu-user-static on a PC to simulate arm64 environment**

```
$ sudo apt-get install qemu-user-static
$ cp /usr/bin/qemu-aarch64-static usr/bin
$ cp -b /etc/resolv.conf etc/
$ cd ../
```

#### 4. Simulate arm64 environment (copy the content to ch-mount.sh)

```
$ vi ch-mount.sh
#!/bin/bash
#

function mnt() {
    echo "MOUNTING"
    sudo mount -t proc /proc ${2}proc
    sudo mount -t sysfs /sys ${2}sys
    sudo mount -o bind /dev ${2}dev
    sudo mount -o bind /dev/pts ${2}dev/pts
    sudo chroot ${2}
}

function umnt() {
    echo "UNMOUNTING"
    sudo umount ${2}proc
    sudo umount ${2}sys
    sudo umount ${2}dev/pts
    sudo umount ${2}dev
}

if [ "$1" == "-m" ] && [ -n "$2" ];
then
    mnt $1 $2
elif [ "$1" == "-u" ] && [ -n "$2" ];
then
    umnt $1 $2
```

```
else
    echo ""
    echo "Either 1'st, 2'nd or both parameters were missing"
    echo ""
    echo "1'st parameter can be one of these: -m(mount) OR -u(umount)"
    echo "2'nd parameter is the full path of rootfs directory(with trailing
'/' )"
    echo ""
    echo "For example: ch-mount -m /media/sdcard/"
    echo ""
    echo 1st parameter : ${1}
    echo 2nd parameter : ${2}
fi
```

#### 5. Simulate arm64 environment (chroot to arm64 filesystem).

```
$ chmod a+x ch-mount.sh
$ ./ch-mount.sh -m ubuntu-rootfs/
```

#### 6. Install the package and configuration

```
# chmod 777 tmp
# apt-get update
# apt-get upgrade
# apt-get install apt-utils language-pack-en-base sudo ssh net-tools
network-manager iputils-ping rsyslog bash-completion htop resolvconf
dialog vim udhcpc alsa-utils
# unminimize
```

## 7. Add user

```
# useradd -s '/bin/bash' -m -G adm,sudo,video,audio user
# echo "Set password for user:"
# passwd user
# echo "Set password for root:"
# passwd root
# echo 'ubuntu.user' > /etc/hostname
```

## 8. Exit the simulate arm64 environment

```
# exit
$ ./ch-mount.sh -u ubuntu-rootfs/
```

## 9. Copy install files...

```
$ sudo cp -Pra ~/imx-yocto-bsp-5.4.70_2.3.3/imx8mpevk_fsl-imx-xwayland/tmp/work/all-poky-linux/firmware-imx/1_8.10.1-r0/image/* ~/ubuntu-rootfs/
$ sudo cp -Pra ~/imx-yocto-bsp-5.4.70_2.3.3/imx8mpevk_fsl-imx-xwayland/tmp/work/all-poky-linux/firmware-imx/1_8.10.1-r0/image/lib/* ~/ubuntu-rootfs/lib/
$ sudo cp -Pra ~/imx-yocto-bsp-5.4.70_2.3.3/imx8mpevk_fsl-imx-xwayland/tmp/work/imx8mpevk-poky-linux/imx-image-full/1.0-r0/rootfs/lib/modules/ ~/ubuntu-rootfs/lib/
$ sudo cp -Pra ~/imx-yocto-bsp-5.4.70_2.3.3/imx8mpevk_fsl-imx-xwayland/tmp/work/imx8mpevk-poky-linux/imx-image-full/1.0-r0/rootfs/lib/firmware/* ~/ubuntu-rootfs/lib/firmware/
$ sudo cp -Pra ~/imx-yocto-bsp-5.4.70_2.3.3/imx8mpevk_fsl-imx-xwayland/tmp/work/imx8mpevk-poky-linux/imx-image-full/1.0-r0/rootfs/boot/* ~/ubuntu-rootfs/boot/
$ sudo cp -Pra ~/imx-yocto-bsp-5.4.70_2.3.3/imx8mpevk_fsl-imx-xwayland/tmp/work/imx8mpevk-poky-linux/alsa-state/0.2.0-r5/image/var/lib/alsa/asound.state ~/ubuntu-rootfs/var/lib/alsa/
$ sudo cp -Pra ~/imx-yocto-bsp-5.4.70_2.3.3/sources/meta-ec25/recipes-ec25/ec25/ec25/quectel-CM ~/ubuntu-rootfs/usr/bin/
$ sudo cp -Pra ~/imx-yocto-bsp-5.4.70_2.3.3/sources/meta-ec25/recipes-ec25/ec25/ec25/simcom-cm ~/ubuntu-rootfs/usr/bin/
```

## 10. Build image (change Yocto rootfs to Ubuntu rootfs)

```
$ mv ~/imx-yocto-bsp-5.4.70_2.3.3/imx8mpevk_fsl-imx-xwayland/  
tmp/work/imx8mpevk-poky-linux/imx-image-full/1.0-r0/rootfs ~/  
imx-yocto-bsp-5.4.70_2.3.3/imx8mpevk_fsl-imx-xwayland/tmp/work/  
imx8mpevk-poky-linux/imx-image-full/1.0-r0/rootfs_bak  
$ sudo cp -Pra ~/ubuntu-rootfs/ ~/imx-yocto-bsp-5.4.70_2.3.3/  
imx8mpevk_fsl-imx-xwayland/tmp/work/imx8mpevk-poky-linux/imx-  
image-full/1.0-r0/rootfs  
$ sudo chown -hR user:user ~/imx-yocto-bsp-5.4.70_2.3.3/  
imx8mpevk_fsl-imx-xwayland/tmp/work/imx8mpevk-poky-linux/imx-  
image-full/1.0-r0/rootfs  
$ sudo chown root:root ~/imx-yocto-bsp-5.4.70_2.3.3/imx8mpevk_fsl-  
imx-xwayland/tmp/work/imx8mpevk-poky-linux/imx-image-full/1.0-r0/  
rootfs/usr/lib/policykit-1/polkit-agent-helper-1  
$ sudo chmod +s ~/imx-yocto-bsp-5.4.70_2.3.3/imx8mpevk_fsl-imx-  
xwayland/tmp/work/imx8mpevk-poky-linux/imx-image-full/1.0-r0/  
rootfs/usr/lib/policykit-1/polkit-agent-helper-1  
$ cd ~/imx-yocto-bsp-5.4.70_2.3.3/imx8mpevk_fsl-imx-xwayland/  
$ bitbake imx-image-full -c do_image_wic -f
```

## 11. Ubuntu image is built complete

```
~/imx-yocto-bsp-5.4.70_2.3.3/imx8mpevk_fsl-imx-xwayland/tmp/  
work/imx8mpevk-poky-linux/imx-image-full/1.0-r0/deploy-imx-image-  
full-image-complete/imx-image-full-imx8mpevk-20220103030143.  
rootfs.wic.bz2
```



## Android

1. Please refer to NXP i.MX Android™ User's Guide:  
[https://www.nxp.com/docs/en/user-guide/ANDROID\\_USERS\\_GUIDE.pdf](https://www.nxp.com/docs/en/user-guide/ANDROID_USERS_GUIDE.pdf)
2. Please download Android Q10.0.0\_2.6.0 BSP(imx-android-10.0.0\_2.6.0) from NXP website
3. Please copy Android BSP (Android10\_2.6.0.tar.gz) provide by NEXCOM to Android Q10.0.0\_2.6.0 BSP (imx-android-10.0.0\_2.6.0) from NXP website as following command:

```
$ cd ~
$ tar xvf ~/Android10_2.6.0.tar.gz
$ cp -rf ~/Android10_2.6.0/* ~/imx-android-10.0.0_2.6.0/android_
build/
$ export AARCH64_GCC_CROSS_COMPILE=/opt/gcc-arm-8.3-
2019.03-x86_64-aarch64-linux-gnu/bin/aarch64-linux-gnu-
$ cd ~/imx-android-10.0.0_2.6.0
$ cd android_build
$ export MY_ANDROID=`pwd`
$ source build/envsetup.sh
$ lunch evk_8mp-userdebug
$ ./imx-make.sh -j4 2>&1 | tee -a build-log.txt
```



5. Please select kernel device tree at u-boot console for display selection:

1. HDMI display (default):

```
Normal Boot
Hit any key to stop autoboot: 0
u-boot=>
u-boot=> setenv fdt_file imx8mp-cps50-hdmi.dtb
u-boot=> saveenv
u-boot=> boot
```

2. HDMI + LVDS panel display:

```
Normal Boot
Hit any key to stop autoboot: 0
u-boot=>
u-boot=> setenv fdt_file imx8mp-cps50-lvds-panel-hdmi.dtb
u-boot=> saveenv
u-boot=> boot
```

3. HDMI + MIPI panel display:

```
Normal Boot
Hit any key to stop autoboot: 0
u-boot=>
u-boot=> setenv fdt_file imx8mp-cps50-mipi-panel-hdmi.dtb
u-boot=> saveenv
u-boot=> boot
```

4. HDMI + LVDS + MIPI panel display:

```
Normal Boot
Hit any key to stop autoboot: 0
u-boot=>
u-boot=> setenv fdt_file imx8mp-cps50.dtb
u-boot=> saveenv
u-boot=> boot
```

## Ubuntu

1. Please refer to NXP i.MX Linux User's Guide for burn image Chapter 4.2 Universal update utility:  
[https://www.nxp.com/docs/en/user-guide/IMX\\_LINUX\\_USERS\\_GUIDE.pdf](https://www.nxp.com/docs/en/user-guide/IMX_LINUX_USERS_GUIDE.pdf)
2. Please download image from website provided by NEXCOM and use the following command to burn image:

```
uuu.exe -b emmc_all imx-boot-imx8mpevk-sd.bin-flash_evk-2GB-uart1-console-hdmi imx-image-full-imx8mpevk-20220105094022.rootfs.wic.bz2
```

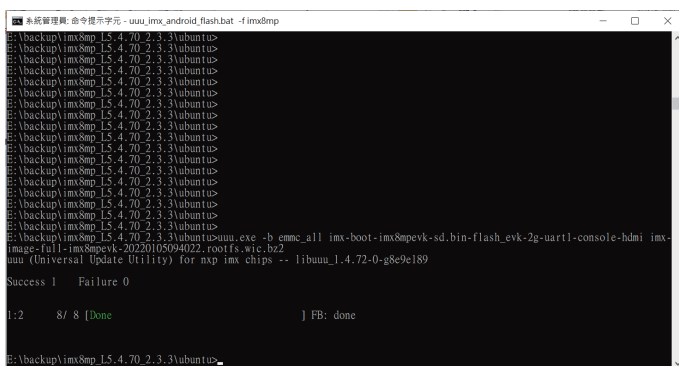

```

root@ubuntu:~# uuu -b emmc_all imx-boot-imx8mpevk-sd.bin-flash_evk-2GB-uart1-console-hdmi imx-image-full-imx8mpevk-20220105094022.rootfs.wic.bz2
uuu (Universal Update Utility) for nxp imx chips -- libuuu_1.4.72-0-g8e9e189
Success 1  Failure 0
1:2  8/ 8 [Done]          ] FB: done
root@ubuntu:~#

```

3. Please login & install ubuntu desktop at boot console as below command:

```

Ubuntu 20.04.2 LTS ubuntu.user ttyMXC0
ubuntu login: user
Password: user
Welcome to Ubuntu 20.04.2 LTS (GNU/Linux 5.4.70-2.3.2+g8c73bc625c4d aarch64)
user@ubuntu:~$ sudo apt-get update
user@ubuntu:~$ sudo apt-get upgrade
user@ubuntu:~$ sudo apt-get install tasksel
user@ubuntu:~$ sudo tasksel install ubuntu-desktop
user@ubuntu:~$ sudo apt-get install ubuntu-software
user@ubuntu:~$ sudo reboot

```

4. Please select kernel device tree at u-boot console for display selection:

1. HDMI display (default):

```
Normal Boot
Hit any key to stop autoboot: 0
u-boot=>
u-boot=> setenv fdt_file imx8mp-cps50-hdmi.dtb
u-boot=> saveenv
u-boot=> boot
```

2. HDMI + LVDS panel display:

```
Normal Boot
Hit any key to stop autoboot: 0
u-boot=>
u-boot=> setenv fdt_file imx8mp-cps50-lvds-panel-hdmi.dtb
u-boot=> saveenv
u-boot=> boot
```

3. HDMI + MIPI panel display:

```
Normal Boot
Hit any key to stop autoboot: 0
u-boot=>
u-boot=> setenv fdt_file imx8mp-cps50-mipi-panel-hdmi.dtb
u-boot=> saveenv
u-boot=> boot
```

4. HDMI + LVDS + MIPI panel display:

```
Normal Boot
Hit any key to stop autoboot: 0
u-boot=>
u-boot=> setenv fdt_file imx8mp-cps50.dtb
u-boot=> saveenv
u-boot=> boot
```

## Android

1. Please refer to NXP Android Quick Start Guide for burn image Chapter 5.3 Flashing board images:  
[https://www.nxp.com/docs/en/quick-reference-guide/ANDROID\\_QUICK\\_START\\_GUIDE.pdf](https://www.nxp.com/docs/en/quick-reference-guide/ANDROID_QUICK_START_GUIDE.pdf)

2. Please download image from website provided by NEXCOM and use the following command to burn image:

1. HDMI display:

```
uuu_imx_android_flash.bat -f imx8mp -e -d hdmi
```

2. HDMI + LVDS + MIPI panel display:

```
uuu_imx_android_flash.bat -f imx8mp -e
```

3. HDMI + LVDS panel display:

```
uuu_imx_android_flash.bat -f imx8mp -e -d lvds-panel
```

4. HDMI + MIPI panel display:

```
uuu_imx_android_flash.bat -f imx8mp -e -d mipi-panel
```

For example:

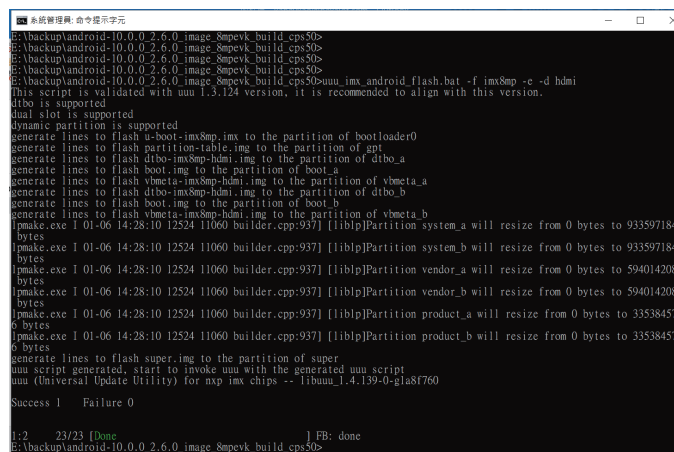

```

E:\Backup\android-10.0.0.2.6.0_image_8mpevk_build_cps50>
E:\Backup\android-10.0.0.2.6.0_image_8mpevk_build_cps50>
E:\Backup\android-10.0.0.2.6.0_image_8mpevk_build_cps50>
E:\Backup\android-10.0.0.2.6.0_image_8mpevk_build_cps50>uuu_imx_android_flash.bat -f imx8mp -e -d hdmi
This script is validated with uuu 1.3.124 version, it is recommended to align with this version.
dtbo is supported
dual slot is supported
dynamic partition is supported
generate lines to flash u-boot-imx8mp.img to the partition of bootloader0
generate lines to flash partition-table.img to the partition of gpt
generate lines to flash dtbo-imx8mp-hdmi.img to the partition of dtbo_a
generate lines to flash boot.img to the partition of boot_a
generate lines to flash vbmeta-imx8mp-hdmi.img to the partition of vbmeta_a
generate lines to flash dtbo-imx8mp-hdmi.img to the partition of dtbo_b
generate lines to flash boot.img to the partition of boot_b
generate lines to flash vbmeta-imx8mp-hdmi.img to the partition of vbmeta_b
Ipmake.exe I 01-06 14:28:10 12524 11060 builder.cpp:937] [libl]Partition system_a will resize from 0 bytes to 933597184
bytes
Ipmake.exe I 01-06 14:28:10 12524 11060 builder.cpp:937] [libl]Partition system_b will resize from 0 bytes to 933597184
bytes
Ipmake.exe I 01-06 14:28:10 12524 11060 builder.cpp:937] [libl]Partition vendor_a will resize from 0 bytes to 594014208
bytes
Ipmake.exe I 01-06 14:28:10 12524 11060 builder.cpp:937] [libl]Partition vendor_b will resize from 0 bytes to 594014208
bytes
Ipmake.exe I 01-06 14:28:10 12524 11060 builder.cpp:937] [libl]Partition product_a will resize from 0 bytes to 33538457
6 bytes
Ipmake.exe I 01-06 14:28:10 12524 11060 builder.cpp:937] [libl]Partition product_b will resize from 0 bytes to 33538457
6 bytes
generate lines to flash super.img to the partition of super
uuu script generated, start to invoke uuu with the generated uuu script
uuu (Universal Update Utility) for nxp imx chips -- libuuu 1.4.139-0-g1a8f760
Success 1 Failure 0

I:2 23/23 [Done] ] FB: done
E:\Backup\android-10.0.0.2.6.0_image_8mpevk_build_cps50>

```

## Yocto Linux Test Command on CPS50

### HDMI

1. Disable Weston UI

```
# killall weston
```

2. Get "connect ID" and "support resolutions"

```
# modetest -c
```

```
id  encoder status      name      size (mm)  modes  encoders
42  41      connected  HDMI-A-1  600x340    13    41
```

```
modes:
```

```
index name refresh (Hz) hdisp hss hse htot vdisp vss vse vtot)
```

```
#0 1920x1080 60.00 1920 2008 2052 2200 1080 1084 1089 1125 148500 flags: phsync, pvsync; type: preferred, driver
#1 1920x1080 59.94 1920 2008 2052 2200 1080 1084 1089 1125 148352 flags: phsync, pvsync; type: driver
#2 1280x1024 75.02 1280 1296 1440 1688 1024 1025 1028 1066 135000 flags: phsync, pvsync; type: driver
#3 1280x1024 60.02 1280 1328 1440 1688 1024 1025 1028 1066 108000 flags: phsync, pvsync; type: driver
#4 1280x960 60.00 1280 1376 1488 1800 960 961 964 1000 108000 flags: phsync, pvsync; type: driver
#5 1280x720 60.00 1280 1390 1430 1650 720 725 730 750 74250 flags: phsync, pvsync; type: driver
#6 1280x720 59.94 1280 1390 1430 1650 720 725 730 750 74176 flags: phsync, pvsync; type: driver
#7 800x600 60.32 800 840 968 1056 600 601 605 628 40000 flags: phsync, pvsync; type: driver
#8 800x600 56.25 800 824 896 1024 600 601 603 625 36000 flags: phsync, pvsync; type: driver
#9 720x480 60.00 720 736 798 858 480 489 495 525 27027 flags: nhsync, nvsync; type: driver
#10 720x480 59.94 720 736 798 858 480 489 495 525 27000 flags: nhsync, nvsync; type: driver
#11 640x480 60.00 640 656 752 800 480 490 492 525 25200 flags: nhsync, nvsync; type: driver
#12 640x480 59.94 640 656 752 800 480 490 492 525 25175 flags: nhsync, nvsync; type: driver
```

### 3. Play colorbar of the specified resolution on HDMI

```
# modetest -s 42:1920x1080-60
# modetest -s 42:1280x1024-60.02
# modetest -s 42:1280x960-60
# modetest -s 42:1280x720-60
# modetest -s 42:800x600-60.32
# modetest -s 42:720x480-60
# modetest -s 42:640x480-60
```

### LVDS panel backlight

```
# echo 100 > /sys/class/backlight/lvds_backlight/brightness
# echo 50 > /sys/class/backlight/lvds_backlight/brightness
# echo 0 > /sys/class/backlight/lvds_backlight/brightness
```



## MIPI-DSI panel backlight

```
# echo 255 > /sys/class/backlight/32e60000.mipi_dsi.0/brightness
# echo 100 > /sys/class/backlight/32e60000.mipi_dsi.0/brightness
# echo 0 > /sys/class/backlight/32e60000.mipi_dsi.0/brightness
```

```
# echo 100 > /sys/class/backlight/mipi_dsi_backlight/brightness
# echo 50 > /sys/class/backlight/mipi_dsi_backlight/brightness
# echo 0 > /sys/class/backlight/mipi_dsi_backlight/brightness
```

## Camera

### Preview

```
# gst-launch-1.0 v4l2src device=/dev/video1 ! video/x-raw,width=1920
,height=1080,framerate=30/1 ! imxvideoconvert_g2d ! fpsdisplaysink
```

### Capture

```
# gst-launch-1.0 v4l2src device=/dev/video1 num-buffers=1 ! video/x-
raw,width=640,height=480 ! jpegenc ! filesink location=sample.jpeg
```

### Record

```
# gst-launch-1.0 v4l2src device=/dev/video1 num-buffers=300
! video/x-raw,format=NV12,width=1920,height=1080,framerate=30/1 ! queue ! vpuenc_h264 ! h264parse ! mp4mux ! filesink
location=sample.mp4
```

## Audio

### Set MIC and speaker

```
# alsamixer
# amixer -c wm8960audio contents
# amixer -c wm8960audio cset name='ALC Function' 3
# amixer -c wm8960audio cset name='ADC PCM Capture Volume' 230
# amixer -c wm8960audio cset name='Capture Volume' 60
# amixer -c wm8960audio cset name='Speaker Playback Volume' 120
# amixer -c wm8960audio cset name='Playback Volume' 235

# alsamixer
# amixer -c wm8962audio contents
# amixer -c wm8962audio cset name='Digital Capture Volume' 108
# amixer -c wm8962audio cset name='Capture Volume' 40
# amixer -c wm8962audio cset name='Capture Switch' 1
# amixer -c wm8962audio cset name='ADC High Performance Switch'
0
# amixer -c wm8962audio cset name='MIXINR PGA Switch' 1
# amixer -c wm8962audio cset name='MIXINL IN2L Switch' 1
# amixer -c wm8962audio cset name='MIXINL PGA Switch' 1
# amixer -c wm8962audio cset name='INPGAR IN1R Switch' 1
# amixer -c wm8962audio cset name='INPGAL IN2L Switch' 1
# amixer -c wm8962audio cset name='Digital Playback Volume' 96
# amixer -c wm8962audio cset name='Speaker Volume' 114
```

### Record

```
# arecord -D sysdefault:CARD=wm8960audio -f S32_LE -r 48000 -t
wav -c 2 /run/media/sda1/test2_32bit_48000.wav
# arecord -D sysdefault:CARD=wm8960audio -f S16_LE -r 48000 -t
wav -c 1 /run/media/sda1/test1_16bit_48000.wav

# arecord -D sysdefault:CARD=wm8962audio -f S32_LE -r 48000 -t
wav -c 2 /run/media/sda1/test1_32bit_48000.wav
# arecord -D sysdefault:CARD=wm8962audio -f S24_LE -r 48000 -t
wav -c 2 /run/media/sda1/test2_24bit_48000.wav
# arecord -D sysdefault:CARD=wm8962audio -f S16_LE -r 48000 -t
wav -c 2 /run/media/sda1/test3_16bit_48000.wav
# arecord -D sysdefault:CARD=wm8962audio -f S16_LE -r 48000 -t
wav -c 1 /run/media/sda1/test4_16bit_48000.wav
```

## Playback

```
# aplay -D sysdefault:CARD=wm8960audio /run/media/sda1/sample1.wav
# aplay -D sysdefault:CARD=audiohdmi /run/media/sda1/sample1.wav
# gplay-1.0 /run/media/sda1/sample1.mp3 --audio-sink="alsasink device=sysdefault:CARD=wm8960audio"
# gplay-1.0 /run/media/sda1/sample1.mp3 --audio-sink="alsasink device=sysdefault:CARD=audiohdmi"
# gst-play-1.0 /run/media/sda1/sample1.mp3 --audiosink="alsasink device=sysdefault:CARD=wm8960audio"
# gst-play-1.0 /run/media/sda1/sample1.mp3 --audiosink="alsasink device=sysdefault:CARD=audiohdmi"
# gst-launch-1.0 playbin uri=file:///run/media/sda1/sample1.mp3 audio-sink="alsasink device=sysdefault:CARD=wm8960audio"
# gst-launch-1.0 playbin uri=file:///run/media/sda1/sample1.mp3 audio-sink="alsasink device=sysdefault:CARD=audiohdmi"
```

```
# aplay -D sysdefault:CARD=wm8962audio /run/media/sda1/sample1.wav
# aplay -D sysdefault:CARD=audiohdmi /run/media/sda1/sample1.wav
# gplay-1.0 /run/media/sda1/sample1.mp3 --audio-sink="alsasink device=sysdefault:CARD=wm8962audio"
# gplay-1.0 /run/media/sda1/sample1.mp3 --audio-sink="alsasink device=sysdefault:CARD=audiohdmi"
# gst-play-1.0 /run/media/sda1/sample1.mp3 --audiosink="alsasink device=sysdefault:CARD=wm8962audio"
# gst-play-1.0 /run/media/sda1/sample1.mp3 --audiosink="alsasink device=sysdefault:CARD=audiohdmi"
# gst-launch-1.0 playbin uri=file:///run/media/sda1/sample1.mp3 audio-sink="alsasink device=sysdefault:CARD=wm8962audio"
# gst-launch-1.0 playbin uri=file:///run/media/sda1/sample1.mp3 audio-sink="alsasink device=sysdefault:CARD=audiohdmi"
```

## Wi-Fi

```
# modprobe moal mod_para=nxp/wifi_mod_para.conf
The SSID & PASSWORD of WIFI AP will be connect
# wpa_passphrase "SSID" "PASSWORD" >> /etc/wpa_supplicant.conf
# wpa_supplicant -d -B -i wlan0 -c /etc/wpa_supplicant.conf -Dnl80211
# ifconfig wlan0 up
# udhcpc -i wlan0
```

## Bluetooth

```
# modprobe moal mod_para=nxp/wifi_mod_para.conf
# hciattach /dev/ttymx2 any 115200 flow
# hciconfig hci0 up
# hcitool -i hci0 cmd 0x3f 0x0009 0xc0 0xc6 0x2d 0x00
# killall hciattach
# hciattach /dev/ttymx2 any -s 3000000 3000000 flow
# hciconfig hci0 up
# hciconfig -a
# bluetoothctl
[bluetooth]# discoverable on
[bluetooth]# pairable on
[bluetooth]# scan on
[NEW] Device 28:7F:CF:F3:EA:52 28-7F-CF-F3-EA-52
[bluetooth]# scan off
[bluetooth]# pair 28:7F:CF:F3:EA:52
[bluetooth]# connect 28:7F:CF:F3:EA:52
```

## Ethernet

Connect the cable and check the Ethernet device and ping test

```
# ifconfig
```

```
root@imx8mpevk:~# ifconfig
eth0  Link encap:Ethernet  HWaddr de:4c:86:37:70:04
       inet addr:10.12.1.45  Bcast:10.12.1.255  Mask:255.255.255.0
       inet6 addr: fe80::dc4c:86ff:fe37:7004/64  Scope:Link
       UP BROADCAST RUNNING MULTICAST  MTU:1500  Metric:1
       RX packets:705 errors:0 dropped:59 overruns:0 frame:0
       TX packets:79 errors:0 dropped:0 overruns:0 carrier:0
       collisions:0 txqueuelen:1000
       RX bytes:60520 (59.1 KiB)  TX bytes:10715 (10.4 KiB)

eth1  Link encap:Ethernet  HWaddr f2:b8:95:28:c5:03
       UP BROADCAST MULTICAST  MTU:1500  Metric:1
       RX packets:0 errors:0 dropped:0 overruns:0 frame:0
       TX packets:0 errors:0 dropped:0 overruns:0 carrier:0
       collisions:0 txqueuelen:1000
       RX bytes:0 (0.0 B)  TX bytes:0 (0.0 B)
       Interrupt:45

lo    Link encap:Local Loopback
       inet addr:127.0.0.1  Mask:255.0.0.0
       inet6 addr: ::1/128  Scope:Host
       UP LOOPBACK RUNNING  MTU:65536  Metric:1
       RX packets:3566 errors:0 dropped:0 overruns:0 frame:0
       TX packets:3566 errors:0 dropped:0 overruns:0 carrier:0
       collisions:0 txqueuelen:1000
       RX bytes:218960 (213.8 KiB)  TX bytes:218960 (213.8 KiB)
```

```
# ping 8.8.8.8
```

```
root@imx8mpevk:~# ping 8.8.8.8
PING 8.8.8.8 (8.8.8.8) 56(84) bytes of data:
64 bytes from 8.8.8.8: icmp_seq=1 ttl=55 time=3.92 ms
64 bytes from 8.8.8.8: icmp_seq=2 ttl=55 time=3.49 ms
64 bytes from 8.8.8.8: icmp_seq=3 ttl=55 time=4.64 ms
^C
--- 8.8.8.8 ping statistics ---
3 packets transmitted, 3 received, 0% packet loss, time 2004ms
rtt min/avg/max/mdev = 3.490/4.014/4.636/0.472 ms
```

## 4G LTE

If SIM card password is 0000, it need to add -p 0000

```
# quectel-CM -i wwan0 -p 0000 &  
# ifconfig wwan0 up  
# udhcpc -i wwan0
```

## CAN bus

```
# ip link set can0 up type can bitrate 125000  
# ip link set can0 up  
# ifconfig can0 up  
# candump can0 &  
# cansend can0 1F334455#1122334455667788
```

## LED

LED ON/OFF test:

```
# echo 255 > /sys/class/leds/led01A/brightness
# echo 0 > /sys/class/leds/led01A/brightness
# echo 255 > /sys/class/leds/led01B/brightness
# echo 0 > /sys/class/leds/led01B/brightness
# echo 255 > /sys/class/leds/status/brightness
# echo 0 > /sys/class/leds/status/brightness
# echo 255 > /sys/class/leds/led02A/brightness
# echo 0 > /sys/class/leds/led02A/brightness
# echo 255 > /sys/class/leds/led02B/brightness
# echo 0 > /sys/class/leds/led02B/brightness
# echo 255 > /sys/class/leds/status_led1/brightness
# echo 0 > /sys/class/leds/status_led1/brightness
# echo 255 > /sys/class/leds/status_led2/brightness
# echo 0 > /sys/class/leds/status_led2/brightness
# echo 255 > /sys/class/leds/status_led3/brightness
# echo 0 > /sys/class/leds/status_led3/brightness
```

NEXCOM IO board (CPSK-501) CAN bus LED:

```
# echo netdev > /sys/class/leds/can0_led/trigger
# echo can0 > /sys/class/leds/can0_led/device_name
# echo 1 > /sys/class/leds/can0_led/link
# echo 1 > /sys/class/leds/can0_led/tx
# echo 1 > /sys/class/leds/can0_led/rx
```

## Serial Port RS-232/RS-422/RS-485

UART1 RS-232

```
# echo 96 > /sys/class/gpio/export
# echo out > /sys/class/gpio/gpio96/direction
# echo 1 > /sys/class/gpio/gpio96/value
# echo 97 > /sys/class/gpio/export
# echo out > /sys/class/gpio/gpio97/direction
# echo 0 > /sys/class/gpio/gpio97/value
# echo 120 > /sys/class/gpio/export
# echo out > /sys/class/gpio/gpio120/direction
Low : Disable Cable Termination:
# echo 0 > /sys/class/gpio/gpio120/value
High : Enable Cable Termination:
# echo 1 > /sys/class/gpio/gpio120/value
# stty -F /dev/ttymx0 -echo -onlcr 115200
# cat /dev/ttymx0 &
# echo "Serial Port Test" > /dev/ttymx0
```

## UART1 RS-422

```
# echo 96 > /sys/class/gpio/export
# echo out > /sys/class/gpio/gpio96/direction
# echo 1 > /sys/class/gpio/gpio96/value
# echo 97 > /sys/class/gpio/export
# echo out > /sys/class/gpio/gpio97/direction
# echo 1 > /sys/class/gpio/gpio97/value
# echo 120 > /sys/class/gpio/export
# echo out > /sys/class/gpio/gpio120/direction
Low : Disable Cable Termination:
# echo 0 > /sys/class/gpio/gpio120/value
High : Enable Cable Termination:
# echo 1 > /sys/class/gpio/gpio120/value
# stty -F /dev/ttymx0 -echo -onlcr 115200
Enable Direction:
# echo 149 > /sys/class/gpio/export
# echo out > /sys/class/gpio/gpio149/direction
# echo 1 > /sys/class/gpio/gpio149/value
# cat /dev/ttymx0 &
# echo "Serial Port Test" > /dev/ttymx0
```

## UART1 RS-485

```
# echo 96 > /sys/class/gpio/export
# echo out > /sys/class/gpio/gpio96/direction
# echo 0 > /sys/class/gpio/gpio96/value
# echo 97 > /sys/class/gpio/export
# echo out > /sys/class/gpio/gpio97/direction
# echo 1 > /sys/class/gpio/gpio97/value
# echo 120 > /sys/class/gpio/export
# echo out > /sys/class/gpio/gpio120/direction
Low : Disable Cable Termination:
# echo 0 > /sys/class/gpio/gpio120/value
High : Enable Cable Termination:
# echo 1 > /sys/class/gpio/gpio120/value
# stty -F /dev/ttymx0 -echo -onlcr 115200
Set Direction Receive:
# echo 149 > /sys/class/gpio/export
# echo out > /sys/class/gpio/gpio149/direction
# echo 0 > /sys/class/gpio/gpio149/value
# cat /dev/ttymx0 &
Set Direction Transmit:
# echo 149 > /sys/class/gpio/export
# echo out > /sys/class/gpio/gpio149/direction
# echo 1 > /sys/class/gpio/gpio149/value
# echo "Serial Port Test" > /dev/ttymx0
```



## UART2 RS-232: (UIO-4030/UIO-4032/UIO-4034)

```
# stty -F /dev/ttymx1 -echo -onlcr 115200
# cat /dev/ttymx1 &
# echo "Serial Port Test" > /dev/ttymx1
```

## UART4 RS-232: (UIO-4032/UIO-4034)

```
# stty -F /dev/ttymx3 -echo -onlcr 115200
# cat /dev/ttymx3 &
# echo "Serial Port Test" > /dev/ttymx3
```

## RS-485: (UIO-4030)

```
# stty -F /dev/ttyUSB0 speed 115200 ignbrk -brkint -icrnl -imaxbel
-opost -onlcr -isig -icanon -iexten -echo -echoe -echok -echoctl -echoke
# cat /dev/ttyUSB0 &
# echo "Serial Port Test" > /dev/ttyUSB0
```

## UART2 RS-232: (NEXCOM IO board) (CPSK-501)

```
# echo 511 > /sys/class/gpio/export
# echo out > /sys/class/gpio/gpio511/direction
# echo 1 > /sys/class/gpio/gpio511/value
# echo 510 > /sys/class/gpio/export
# echo out > /sys/class/gpio/gpio510/direction
# echo 0 > /sys/class/gpio/gpio510/value
# echo 509 > /sys/class/gpio/export
# echo out > /sys/class/gpio/gpio509/direction
Low : Disable Cable Termination:
# echo 0 > /sys/class/gpio/gpio509/value
High : Enable Cable Termination
# echo 1 > /sys/class/gpio/gpio509/value
# stty -F /dev/ttymx1 -echo -onlcr 115200
# cat /dev/ttymx1 &
# echo test > /dev/ttymx1
```

## UART2 RS-485: (NEXCOM IO board) (CPSK-501)

```
# echo 511 > /sys/class/gpio/export
# echo out > /sys/class/gpio/gpio511/direction
# echo 0 > /sys/class/gpio/gpio511/value
# echo 510 > /sys/class/gpio/export
# echo out > /sys/class/gpio/gpio510/direction
# echo 1 > /sys/class/gpio/gpio510/value
# echo 509 > /sys/class/gpio/export
# echo out > /sys/class/gpio/gpio509/direction
Low : Disable Cable Termination:
# echo 0 > /sys/class/gpio/gpio509/value
High : Enable Cable Termination
# echo 1 > /sys/class/gpio/gpio509/value
# stty -F /dev/ttymx1 -echo -onlcr 115200
Set Direction Receive:
# echo 141 > /sys/class/gpio/export
# echo out > /sys/class/gpio/gpio141/direction
# echo 0 > /sys/class/gpio/gpio141/value
# cat /dev/ttymx1 &
Set Direction Transmit:
# echo 141 > /sys/class/gpio/export
# echo out > /sys/class/gpio/gpio141/direction
# echo 1 > /sys/class/gpio/gpio141/value
# echo "Serial Port Test" > /dev/ttymx1
```

## UART4 RS-232: (NEXCOM IO board) (CPSK-501)

```
# echo 508 > /sys/class/gpio/export
# echo out > /sys/class/gpio/gpio508/direction
# echo 1 > /sys/class/gpio/gpio508/value
# echo 507 > /sys/class/gpio/export
# echo out > /sys/class/gpio/gpio507/direction
# echo 0 > /sys/class/gpio/gpio507/value
# echo 506 > /sys/class/gpio/export
# echo out > /sys/class/gpio/gpio506/direction
Low : Disable Cable Termination:
# echo 0 > /sys/class/gpio/gpio506/value
High : Enable Cable Termination
# echo 1 > /sys/class/gpio/gpio506/value
# stty -F /dev/ttymx3 -echo -onlcr 115200
# cat /dev/ttymx3 &
# echo test > /dev/ttymx3
```

## UART4 RS-485: (NEXCOM IO board) (CPSK-501)

```
# echo 508 > /sys/class/gpio/export
# echo out > /sys/class/gpio/gpio508/direction
# echo 0 > /sys/class/gpio/gpio508/value
# echo 507 > /sys/class/gpio/export
# echo out > /sys/class/gpio/gpio507/direction
# echo 1 > /sys/class/gpio/gpio507/value
# echo 506 > /sys/class/gpio/export
# echo out > /sys/class/gpio/gpio506/direction
Low : Disable Cable Termination:
# echo 0 > /sys/class/gpio/gpio506/value
High : Enable Cable Termination
# echo 1 > /sys/class/gpio/gpio506/value
# stty -F /dev/ttymx3 -echo -onlcr 115200
Set Direction Receive:
# echo 140 > /sys/class/gpio/export
# echo out > /sys/class/gpio/gpio140/direction
# echo 0 > /sys/class/gpio/gpio140/value
# cat /dev/ttymx3 &
Set Direction Transmit:
# echo 140 > /sys/class/gpio/export
# echo out > /sys/class/gpio/gpio140/direction
# echo 1 > /sys/class/gpio/gpio140/value
# echo "Serial Port Test" > /dev/ttymx3
```

## UIO-4030: 4 DI & 4 DO

UIO2\_GPIO12 out:

```
# echo 496 > /sys/class/gpio/export
# echo out > /sys/class/gpio/gpio496/direction
# echo 1 > /sys/class/gpio/gpio496/value
```

UIO2\_GPIO10 out:

```
# echo 497 > /sys/class/gpio/export
# echo out > /sys/class/gpio/gpio497/direction
# echo 1 > /sys/class/gpio/gpio497/value
```

UIO2\_GPIO11 in:

```
# echo 498 > /sys/class/gpio/export
# echo in > /sys/class/gpio/gpio498/direction
# cat /sys/class/gpio/gpio498/value
```

UIO2\_GPIO9 in:

```
# echo 499 > /sys/class/gpio/export
# echo in > /sys/class/gpio/gpio499/direction
# cat /sys/class/gpio/gpio499/value
```

UIO2\_GPIO8 out:

```
# echo 500 > /sys/class/gpio/export
# echo out > /sys/class/gpio/gpio500/direction
# echo 1 > /sys/class/gpio/gpio500/value
```

UIO2\_GPIO6 out:

```
# echo 501 > /sys/class/gpio/export
# echo out > /sys/class/gpio/gpio501/direction
# echo 1 > /sys/class/gpio/gpio501/value
```

UIO2\_GPIO7 in:

```
# echo 502 > /sys/class/gpio/export
# echo in > /sys/class/gpio/gpio502/direction
# cat /sys/class/gpio/gpio502/value
```

UIO2\_GPIO5 in:

```
# echo 503 > /sys/class/gpio/export
# echo in > /sys/class/gpio/gpio503/direction
# cat /sys/class/gpio/gpio503/value
```

## UIO-4030: 4 DI & 4 DO

UIO2\_GPIO12 out:

```
# echo 496 > /sys/class/gpio/export
# echo out > /sys/class/gpio/gpio496/direction
# echo 1 > /sys/class/gpio/gpio496/value
```

UIO2\_GPIO10 out:

```
# echo 497 > /sys/class/gpio/export
# echo out > /sys/class/gpio/gpio497/direction
# echo 1 > /sys/class/gpio/gpio497/value
```

UIO2\_GPIO11 in:

```
# echo 498 > /sys/class/gpio/export
# echo in > /sys/class/gpio/gpio498/direction
# cat /sys/class/gpio/gpio498/value
```

UIO2\_GPIO9 in:

```
# echo 499 > /sys/class/gpio/export
# echo in > /sys/class/gpio/gpio499/direction
# cat /sys/class/gpio/gpio499/value
```

UIO2\_GPIO8 out:

```
# echo 500 > /sys/class/gpio/export
# echo out > /sys/class/gpio/gpio500/direction
# echo 1 > /sys/class/gpio/gpio500/value
```

UIO2\_GPIO6 out:

```
# echo 501 > /sys/class/gpio/export
# echo out > /sys/class/gpio/gpio501/direction
# echo 1 > /sys/class/gpio/gpio501/value
```

UIO2\_GPIO7 in:

```
# echo 502 > /sys/class/gpio/export
# echo in > /sys/class/gpio/gpio502/direction
# cat /sys/class/gpio/gpio502/value
```

UIO2\_GPIO5 in:

```
# echo 503 > /sys/class/gpio/export
# echo in > /sys/class/gpio/gpio503/direction
# cat /sys/class/gpio/gpio503/value
```

## NEXCOM IO board (CPSK-501) UIO\_GPIO

UIO\_GPIO4 out:

```
# echo 496 > /sys/class/gpio/export
# echo out > /sys/class/gpio/gpio496/direction
# echo 1 > /sys/class/gpio/gpio496/value
```

UIO\_GPIO3 out:

```
# echo 497 > /sys/class/gpio/export
# echo out > /sys/class/gpio/gpio497/direction
# echo 1 > /sys/class/gpio/gpio497/value
```

UIO\_GPIO2 out:

```
# echo 498 > /sys/class/gpio/export
# echo out > /sys/class/gpio/gpio498/direction
# echo 1 > /sys/class/gpio/gpio498/value
```

UIO\_GPIO1 out:

```
# echo 499 > /sys/class/gpio/export
# echo out > /sys/class/gpio/gpio499/direction
# echo 1 > /sys/class/gpio/gpio499/value
```

UIO\_GPIO4 in:

```
# echo 496 > /sys/class/gpio/export
# echo in > /sys/class/gpio/gpio496/direction
# cat /sys/class/gpio/gpio496/value
```

UIO\_GPIO3 in:

```
# echo 497 > /sys/class/gpio/export
# echo in > /sys/class/gpio/gpio497/direction
# cat /sys/class/gpio/gpio497/value
```

UIO\_GPIO2 in:

```
# echo 498 > /sys/class/gpio/export
# echo in > /sys/class/gpio/gpio498/direction
# cat /sys/class/gpio/gpio498/value
```

UIO\_GPIO1 in:

```
# echo 499 > /sys/class/gpio/export
# echo in > /sys/class/gpio/gpio499/direction
# cat /sys/class/gpio/gpio499/value
```

## RTC

Set system time to current, then write to RTC:

```
# date 102308262021 && hwclock -w && date
Sat Oct 23 08:26:00 UTC 2021
Sat Oct 23 08:26:01 UTC 2021
```

Set one incorrect time, then read time from RTC to verify:

```
# date 010100002000 && hwclock -r && date
Sat Jan 1 00:00:00 UTC 2000
2021-10-23 08:26:15.309612+00:00
Sat Jan 1 00:00:00 UTC 2000
```

Restore the RTC time to system time:

```
# hwclock -s && date
Sat Oct 23 08:26:33 UTC 2021
```

RTC test:

```
# /unit_tests/SRTC/rtctest.out
```

## Watchdog

System will reboot after 1 sec:

```
# /unit_tests/Watchdog/wdt_driver_test.out 1 2 0
---- Running < /unit_tests/Watchdog/wdt_driver_test.out > test ----
```

```
Starting wdt_driver (timeout: 1, sleep: 2, test: ioctl)
Trying to set timeout value=1 seconds
The actual timeout was set to 1 seconds
Now reading back -- The timeout is 1 seconds
```

```
U-Boot SPL 2020.04-5.4.70-2.3.3+g44f5949dd9 (Mar 31 2022 -
09:00:43 +0000)
```

## USB storage copy file

```
# rsync -av --progress /run/media/sda1/file1 /run/media/sda1/file2
```

## MicroSD card copy file

```
# rsync -av --progress /run/media/mmcbk1p1/file1 /run/media/  
mmcbk1p1/file2
```



## i2c reset PMIC pca9450

```
# echo 06 14 > /sys/devices/platform/soc@0/30800000.bus/30a20000.  
i2c/i2c-0/0-0025/pca9450-pmic/registers
```

## Thermal CPU & SoC temperature

```
# cat /sys/class/thermal/thermal_zone0/temp  
# cat /sys/class/thermal/thermal_zone1/temp
```

## Thermal CPU & SoC passive & critical temperature setting

Commercial:

```
# echo 85000 > /sys/class/thermal/thermal_zone0/trip_point_0_temp  
# echo 95000 > /sys/class/thermal/thermal_zone0/trip_point_1_temp  
# echo 85000 > /sys/class/thermal/thermal_zone1/trip_point_0_temp  
# echo 95000 > /sys/class/thermal/thermal_zone1/trip_point_1_temp
```

Industrial:

```
# echo 95000 > /sys/class/thermal/thermal_zone0/trip_point_0_temp  
# echo 105000 > /sys/class/thermal/thermal_zone0/trip_point_1_temp  
# echo 95000 > /sys/class/thermal/thermal_zone1/trip_point_0_temp  
# echo 105000 > /sys/class/thermal/thermal_zone1/trip_point_1_temp
```

## CPU Frequency

```
# cat /sys/devices/system/cpu/cpu0/cpufreq/cpuinfo_cur_freq
```

## CPU Frequency & CPU & SoC temperature

```
# cpuFreqTemp.sh &  
# cat /home/root/cpu_freq_temp.log
```

## ATECC608A

```
# atecc -b 1 -s 192 -c serial  
0123952aef4c6321ee  
# atecc -b 1 -s 192 -c info  
Found ATECC608A
```

# APPENDIX A: SYSTEM RECOVERY

This section provides detailed procedures for restoring the eMMC image. If you destroy the onboard flash image by accident, you can recover the system by following these steps.

## Before the System Restore

- Ensure you have a stable, clean working environment. Dust and dirt can get into components and cause a malfunction. Use containers to keep small components separated.
- Recovery Image (For more detailed info, please contact NEXAIoT).
- A 64-bit Linux host O/S on a PC (Virtual Machines are not recommended)
- USB cable to connect the host PC to the CPS 50-N01.

## Restoring the Operating System

This section will provide step-by-step the instructions on how to write the image to the eMMC on the CPS 50-N01.

1. Remove the chassis cover, and then CPU heatsink.

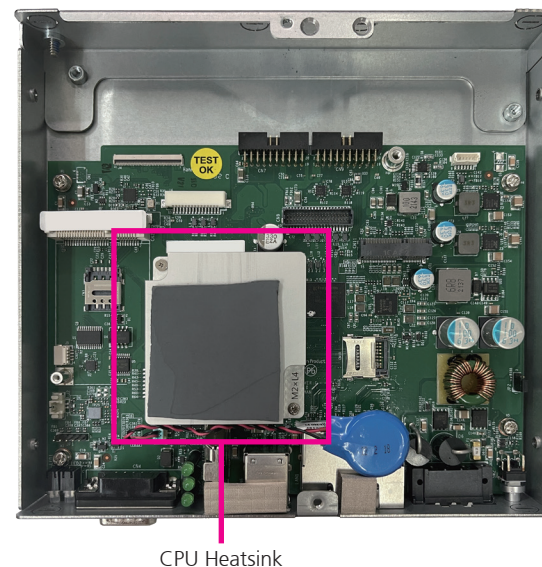

- Find the SW1 on the CPS 50-N01 mainboard and change the SW1 setting to Serial Download (developer) Mode (SW1: PIN1 to OFF , PIN2 to ON) according to the image below:

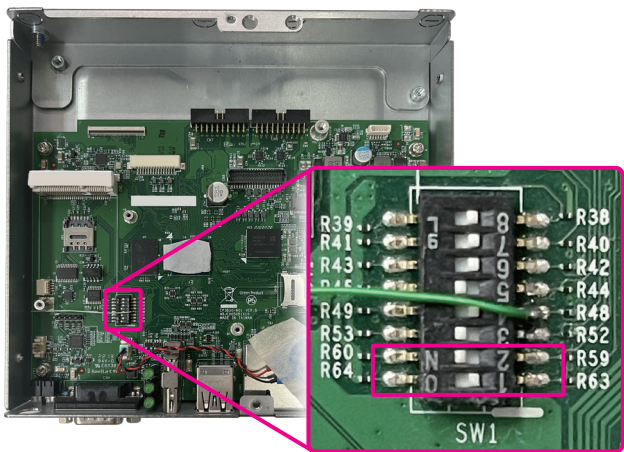

- Turn on the host PC, download the image from the website provided by NEXAIoT, and unzip the image file.
- Connect the USB cable to the host PC. **DO NOT** connect to the CPS 50-N01 at this time.

- Open a terminal application on the host PC and access the location where the image file has been extracted, then use the following command to burn image:

```
uuu.exe -b emmc_all imx-boot-imx8mpevk-sd.bin-flash_evk-2GB-uart1-console-hdmi imx-image-full-imx8mpevk-20220105085751.rootfs.wic.bz2
```

- Connect the DC 12 or 24V cable to the CPS 50-N01 and it will trigger the serial download mode to restore the image from the host PC.
- After the restore process has completed, it will show on the host PC (refer to the image below):

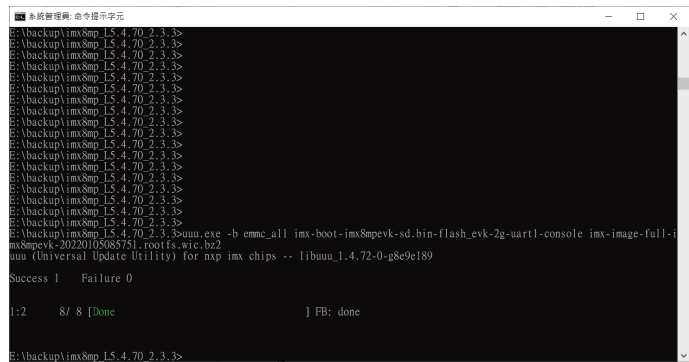

8. Remove the DC 12 or 24V cable on the CPS 50-N01, and set the SW1 switch setting back to Normal mode (SW1: PIN1 to ON, PIN2 to OFF).
9. Put back the CPU heatsink, and fasten two screws.
10. Power on the CPS 50-N01 to see the Linux Yocto OS.
11. Press any key during boot up to access U-boot mode.
12. Put back the chassis cover, and fasten six screws.